

Passing in Review

Where Centurion leads, others must follow.

Once again, Centurion draws the lines that distinguish a leader from its competition. Drawing on the best of two worlds, Centurion has combined the engineering and production genius of Japan with the brilliant design concepts of Europe.

Drawing on years of experience, Centurion has again proven that everything must begin with intensive planning; that the entire spectrum of biking needs must be considered. As a result, Centurion has developed what must be considered the most well thought-out group of bicycles available today. No detail of function or appearance has been overlooked. From frame angles, fork rakes and wheel base to the critical selection of individual components, each Centurion bicycle is designed to fulfill its intended function. Perfectly. As for appearance, Centurion presents the world's first group of individually color-coordinated bicycles. Yet with all their engineering and design value, Centurion bicycles are surprisingly economical to purchase. As you examine the detailed quality of each Centurion bicycle presented here, we think you will draw one unmistakable conclusion: Your Needs as a biking enthusiast have never been served quite so well.

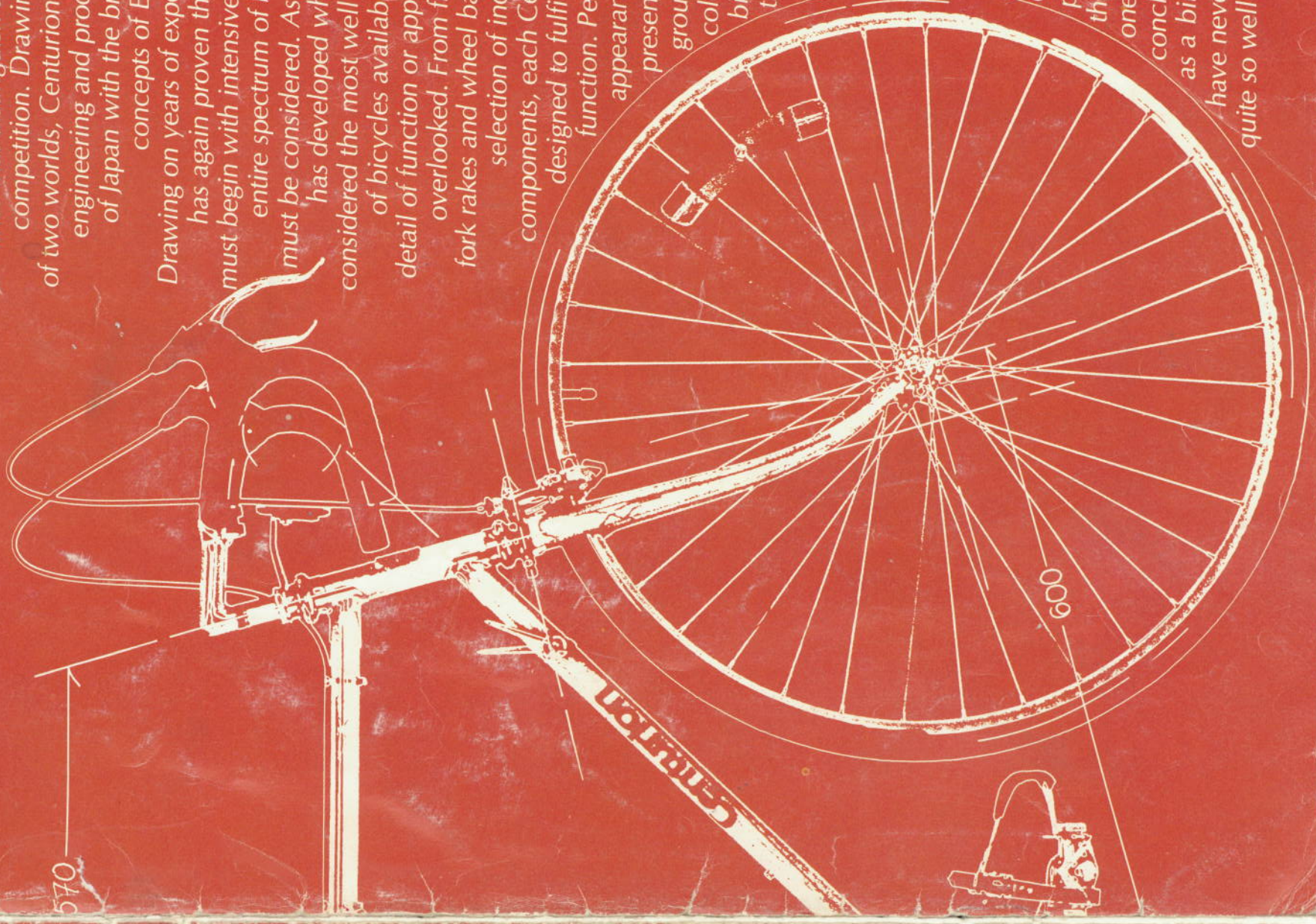

Frame Size:	Semi-Pro	Pro-Tour	Super Elite	Elite	Super Le Mans	Le Mans	Omega	Sport DLX
Frame:	21 1/2" 22 1/2" 23 1/2" 24 1/2" 25 1/2"	21 1/2" 22 1/2" 23 1/2" 24 1/2"	21" 23" 25"	21" 23" 25"	19" 21" 23" 25"	Mens 19" 21" 23" 25"; 26 3/4"; Mixie 19" 21" 23"	Mens 19" 21" 23" 25"; also available 18" with 26 x 1 1/4 wheels	Mens 19" 21" 23" 25"; Ladies 19"
Fork:	Tange Champion double-butted chromoly tubing. Forged concave seat stay. Brazed-on custom seat binder tube. Brazed-on drop outs with axle adjusters. Brazed-on water bottle studs. Chrome lugs	Tange Champion double-butted chromoly tubing. Forged concave seat stay. Brazed-on custom seat binder tube. Brazed-on drop outs. Brazed-on water bottle studs	Tange chromoly tubing, chromed sloping crown, 2 point bend, chromed forged tips.	Tange hi-tension steel tubing, chromed sloping crown, 2 point bend, forged tips.	Tange hi-tension steel tubing, chromed sloping crown, 2 point bend, forged tips.	Hi-tension steel tubing, 3 main tubes butted 1.2mm to 0.9mm. Brazed-on cable stops. Brazed-on rear brake cable hanger. Forged concave seat stay	Tange hi-tension steel tubing, sloping crown, 2 point bend	Hi-tension steel tubing
Head Set:	Tange Falcon	Tange Falcon	Tange Falcon	Centurion	Centurion	Centurion	Centurion	Centurion
Handlebar:	SR World Custom with cloth tape	SR World randomneur with cloth tape	SR alloy Custom with cloth tape	SR alloy Custom with cloth tape	SR 1 1/2" alloy randomneur with cloth tape	15/16" alloy randomneur with cloth tape	15/16" alloy randomneur with cloth tape	15/16" steel with vinyl tape
Stern:	SR New Royal Extra Super Light	Sakae AH forged alloy	Sakae AH forged alloy	Sakae AH forged alloy	Sakae AH forged alloy	Centurion forged alloy with allen head	Centurion forged alloy with allen head	Centurion forged alloy with allen head
Brakes:	Gran Compe 500 side pull with Gran Compe levers and gum hoods	Dia-Compe 610-G forged alloy center pull. Dual brazed-on mounts. Drilled levers with gum hoods	Dia-Compe 500-G alloy side pull with QR, drilled levers, gum hoods	Dia-Compe 500-G alloy side pull with QR, drilled levers, gum hoods	Dia-Compe 500-Q alloy side pull with QR, drilled levers and gum hoods	Dia-Compe alloy center pull with extension levers and QR	Dia-Compe alloy center pull with extension levers and QR	Dia-Compe 500 side pull with extension levers
Derailleurs:	Suntour Cyclone front and Cyclone GT rear with Cyclone shifters	Suntour Cyclone front and Cyclone GT rear, power shifters	Suntour Cyclone front and Cyclone GT rear, power shifters	Suntour NSL front and Cyclone GT rear, power shifters	Suntour VX front and VX-GT rear with Power Stem shifters	Suntour VX front and VX-GT rear with Power Stem shifters	Suntour Seven front and Seven GT rear with LS stem shifters	Shimano FE front and new Centurion rear with LS stem shifters
Cluster:	Suntour Winner steel Tran-Z 13-24 gold	Suntour Tran-Z gold	Suntour Tran-Z gold	Suntour Tran-Z gold	Suntour Tran-Z gold	Suntour Tran-Z 6 gold 14-16-19-23-27-30	Suntour Tran-Z 6 gold 14-16-19-23-27-30	Shimano 14-28 freehub
Chain:	Suntour Tran-Z gold	Suntour Tran-Z gold	Suntour Tran-Z gold	Suntour Tran-Z gold	Suntour Tran-Z gold	Suntour Tran-Z gold	Suntour Tran-Z gold	DID 1/2 x 3/32 black
Crank Set:	Sugino Super Mighty Victory 42-52 with drilled chain rings. 170mm	SR SAX-5 TG triple 34-43-52 170mm	SR SAX-5RG 39-52 170mm with alloy guard	SR Apex 5RG-Z-AH 170mm with alloy guard	Sugino double detachable cotterless alloy 40-52 170mm with alloy guard	MKS Syllvan alloy with toe clips, straps	MKS Syllvan alloy with toe clips, straps	Sugino Tourist cotterless steel with satin steel 40-52 double 5-pin chainwheel with guard
Pedals:	MKS UR-K with toe clips and straps	MKS UR-K with toe clips and straps	MKS Syllvan alloy with toe clips, straps	MKS Syllvan alloy with toe clips, straps	MKS Syllvan alloy with toe clips, straps	MKS OR-K1	MKS OR-K1	MKS 90 rat trap
Wheels:	Araya 700 c 19.6mm alloy clincher with Sunshine Pro AM small flange QR hubs. Stainless steel spokes	Araya 27 x 1 1/4 22mm alloy clincher with Sunshine Pro AM small flange QR hubs. Stainless steel spokes	Araya 27 x 1 1/4 22mm alloy clincher with Sunshine Pro AM small flange QR hubs. Stainless steel spokes	Araya 27 x 1 1/4 22mm alloy clincher with Sunshine alloy small flange QR hubs	Araya 27 x 1 1/4 22mm alloy clincher with Sunshine alloy small flange QR hubs	Araya 27 x 1 1/4 22mm alloy clincher with Suze hi flange hubs, front QR	Araya 27 x 1 1/4 22mm alloy clincher with Suze hi flange hubs, front QR	Araya 27 x 1 1/4 hi-pressure steel clincher with Shimano semi hi-flange hubs
Tires:	Centurion 700c 25mm 250 gr Road Racing Extra 100 psi skin	Centurion 27 x 1 1/4 25mm 250 gr Road Racing Extra 100 psi skin	Centurion 27 x 1 1/4 25mm 250 gr Road Racing Extra 100 psi skin	Centurion 27 x 1 1/4 25mm 250 gr Road Racing Extra 100 psi skin	Centurion 27 x 1 1/4 25mm 250 gr Road Racing Extra 100 psi skin	Centurion 27 x 1 1/4 85 psi hi-pressure gum	Centurion 27 x 1 1/4 85 psi hi-pressure gum	Centurion 27 x 1 1/4 85 psi hi-pressure gum
Saddle:	Kashimax racing saddle	Kashimax racing saddle	Kashimax racing saddle	Kashimax racing saddle	Kashimax racing saddle	Kashimax padded racing	Kashimax padded racing	Padded racing
Seat Post:	SR CTP-5 Laprade type alloy fluted with chromoly dual allen key binder bolt	SR CTP-5 Laprade type alloy fluted with chromoly dual allen key binder bolt	SR CTP-5 Laprade type alloy fluted with chromoly dual allen key binder bolt	SR CTP-5 Laprade type alloy fluted with chromoly dual allen key binder bolt	SR ASP alloy with chromoly dual allen key binder bolt	Chrome plated hi-tension steel	Chrome plated hi-tension steel	Chrome plated hi-tension steel
Extras:	Alloy spoke protector, chain stay protector, stainless steel cable clips, fully reflectorized, color coordinated, pinstriped, touch up paint.	Alloy spoke protector, chain stay protector, stainless steel cable clips, fully reflectorized, color coordinated, pinstriped, touch up paint.	Alloy spoke protector, chain stay protector, stainless steel cable clips, fully reflectorized, color coordinated, pinstriped, touch up paint.	Alloy spoke protector, chain stay protector, stainless steel cable clips, fully reflectorized, color coordinated, pinstriped, touch up paint.	Alloy spoke protector, chain stay protector, stainless steel cable housing with plastic sleeve, stainless cable clips, fully reflectorized, color coordinated, pinstriped, touch up paint.	Alloy spoke protector, chain stay protector, fully reflectorized, color coordinated, pinstriped, touch up paint.	Alloy spoke protector, chain stay protector, fully reflectorized, color coordinated, pinstriped, touch up paint.	Plastic spoke protector, chain stay protector, fully reflectorized, color coordinated
Colors:	Pearlized Cobalt Blue, Pearlized Yellow	Pearlized Maroon, Pearlized Silver	Pearlized Cobalt Blue, Pearlized Silver	Pearlized Maroon, Pearlized Cobalt Blue	Pearlized Maroon, Pearlized Silver, Gloss Black	Pearlized Silver, Pearlized Cobalt Blue, Pearlized Rose (Mixte)	Pearlized Maroon, Pearlized Cobalt Blue, Pearlized Silver	Metallic: Red, Blue, Silver
Weight:	21 lbs.	23 1/2 lbs.	22 1/2 lbs.	25 lbs.	25 lbs.	28 lbs.	30 lbs.	32 lbs.

Centurion bicycles carry a no-time-limit warranty. See your Centurion warranty card.

Centurion is a registered trade name belonging to Western States Import Co., Inc. All rights reserved.
Centurion Bicycle Company
Newbury Park, California
Denver, Colorado

*Listed weights vary according to frame size.

All Centurion bicycles are manufactured and tested to meet all current Federal, State and CPSC safety standards.
Specifications subject to change without notice.

Printed in U.S.A.

Centurion
Where we lead, others must follow

Centurion Semi-Pro

Declaring Supremacy

Designed for the true racing bicycle connoisseur. Its extremely lightweight 10-speed racing configuration offers exceptional handling and response. With its superb componentry, there's little difference between the Centurion Semi-Pro and a handmade, custom machine. Except the price.

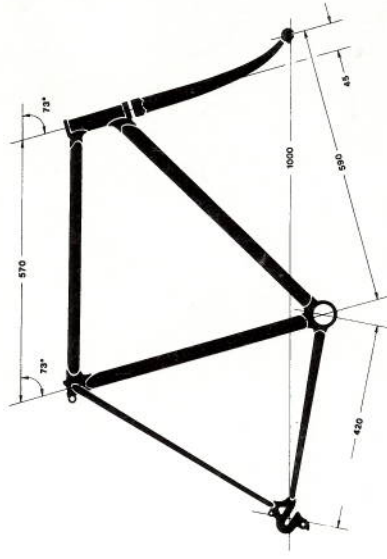

Frame Sizes: 21 1/2", 22 1/2", 23 1/2", 24 1/2", 25 1/2"

Colors: Pearlized Yellow with pinstriping

Pearlized Cobalt Blue with pinstriping



Sunshine Pro-Am small flange, quick release hubs with precision ground races for minimal friction. Stainless steel spokes.

SR New Royal Extra Super Light stem. World Custom engraved handlebar with cloth tape for hand comfort, moisture absorption. Tange professional headset.



Gran Compe 500 side pull brakes for positive response, all-weather braking action. Chrome sloping fork crown, chrome head lug add style. 700c 19.6mm wide alloy rims and 700c Centurion 25mm 100 psi skin tires, for racing performance.



Chrome wrap-around seat stays for strength. Brazed-on seat binder lug with chromoly dual allen head binder bolt for positive locking.

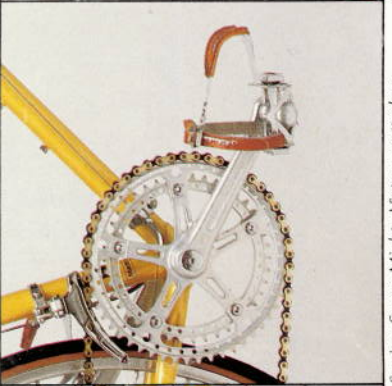

Sugino Super, Mighty Victory cotterless forged aircraft alloy crank set, for perfect chain alignment, minimum friction. Forged aluminum pedals with chromoly spindle, and precision bearing races. Toe clips, toe straps. Pro style brazed-on water bottle holder.



Suntour Cyclone Derailleur system. Most advanced system available. Unique slant parallelogram mechanism enables pulleys to shift diagonally at same angle as sprocket during gear change, retaining uniform clearance between pulleys and sprocket. Result: More stable driving, easier shifting. Suntour's new Tran-Z chain and Tran-Z cluster dramatically improve shifting speed.



Centurion Pro-Tour

Taking Highest Honors

Designed for the long-range touring enthusiast. As the world's most distinguished production touring machine, it is engineered to accommodate every on-tour need, from complete tour accessories to the most versatile 15-speed gearing available.

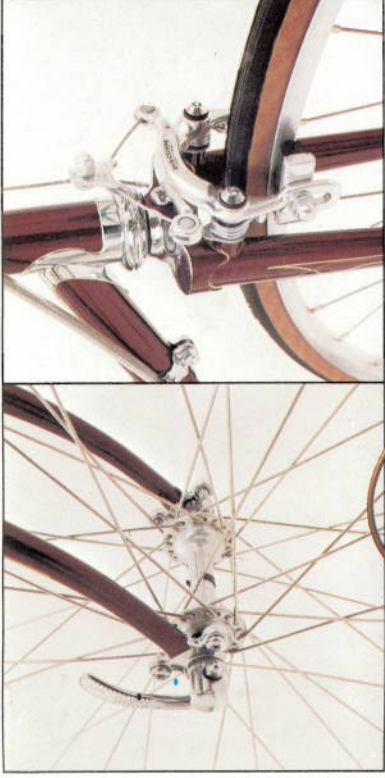

Unique Dia-Compe 610-C brazed-on center pull brakes for extremely positive 2-position stopping. Handsome chrome head lugs, chrome fork crown. 27" 25mm 100psi skin tires mounted on extremely lightweight 19.6mm alloy rims for superb handling.

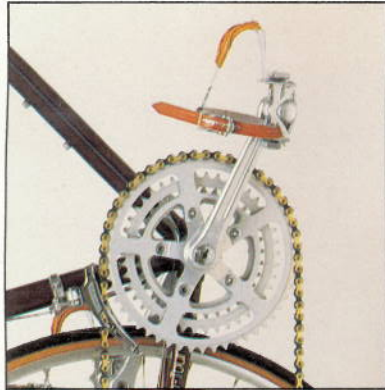

Triple cotterless alloy crank set for 15-speed versatility that accommodates 28 through 54 tooth sprockets gear range. Water bottle holder for on-tour convenience. Forged aluminum pedals with chromoly spindle and precision bearing races.

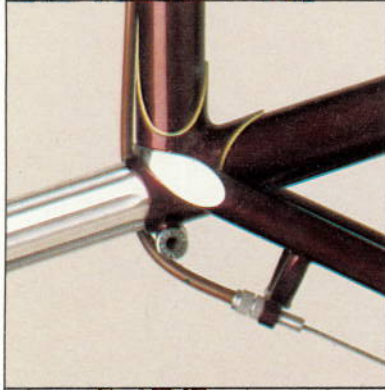

Chrome wrap-around seat stays. Special seat binder tube with chromoly dual allen head binder bolt for strong, positive locking. Brazed-on rear brake cable hanger with stop. Laprade type alloy fluted seat post, lightweight, extremely easy to adjust.



Suntour forged vertical rear drop-outs with dual mounts for pack and mud guard. Suntour Cyclone GT Derailleur system allowing chain removal from Derailleur cage without removing chain link. Suntour Tran-Z gold cluster and chain.

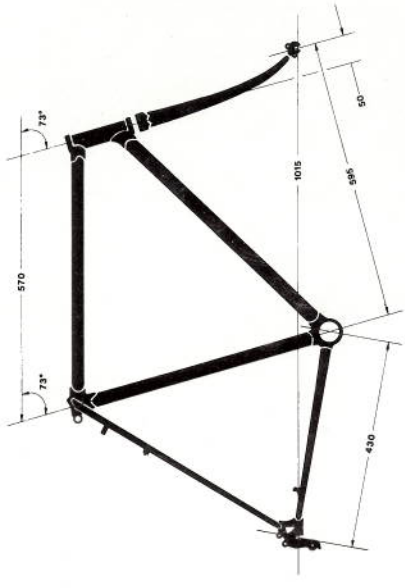

Frame Sizes: 21 1/2", 22 1/2", 23 1/2", 24 1/2"

Colors: Pearlized Maroon with pinstriping

Pearlized Silver with pinstriping



Centurion Super Elite

Outdistancing the Competition

Designed for the upcoming racing enthusiast, the Super Elite is a direct descendant of Centurion's

Semi-Pro. To join the racing class, you won't find more built-in value for the price. Anywhere.

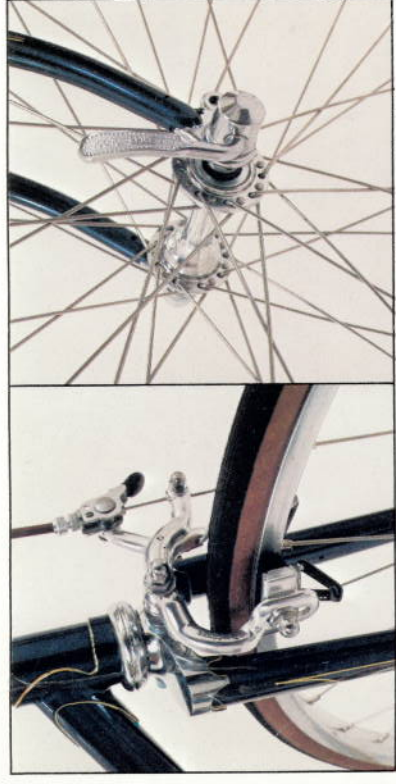

Suntour Vx small flange, quick release hubs, front and rear. Chrome forged fork end. Stainless steel spokes.

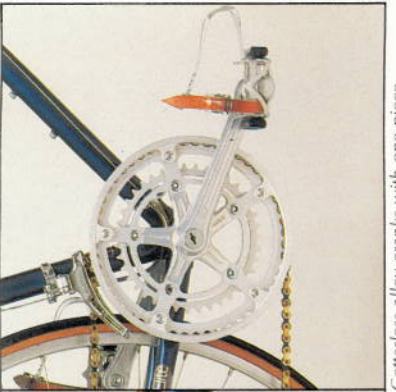

Cotterless alloy cranks with one-piece forged spider. Interchangeable inner and outer sprockets allow versatile "customized" gear ratio changes. Alloy rate-trap pedals with toe clips and straps.

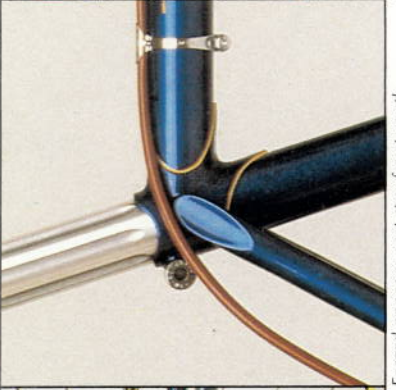

Forged concave seat stay for strength. Specially designed seat binder tube with chromoly allen head binder bolt. Laprade type fluted alloy seat post.

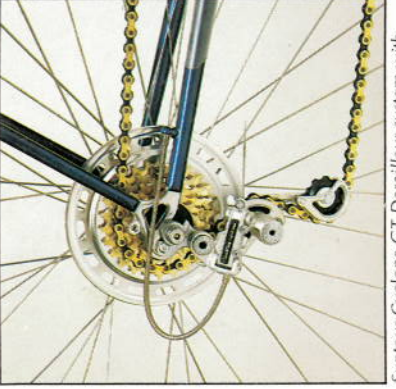

Suntour Cyclone GT Derailleur system with Suntour Tran-Z cluster and chain. Inner edges of chain's outer link plate are deeply scalloped; so chain operates at a sharper angle, engaging cluster teeth more quickly for greater shifting speed.

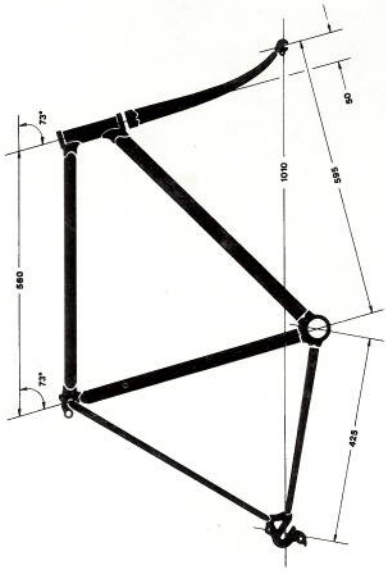

Frame Sizes: 21" 23" 25"

Colors: Pearlized Silver with pinstriping

Pearlized Cobalt Blue with pinstriping



Centurion Elite

Holding the advantage
 Designed for the entry level racing enthusiast, the Elite is a legitimate racing machine fashioned after the Super Elite. It is a high performance machine with quality components and frame technology at a moderate price.



Suntour Cyclone GT Derailleur system with Suntour Train-Z cluster and chain. Inner edges of chain's outer link plate are deeply scalloped; so chain operates at a sharper angle, engaging cluster teeth more quickly for greater shifting speed.

Forged concave seat stay for strength. Specially designed seat binder tube with chromoly allen head binder bolt. Laprade type fluted alloy seat post.

5 arm cotterless alloy cranks with interchangeable inner and outer sprockets for versatile, customized gear ratio changes. Alloy rat trap pedals with toe clips and straps.

Dia-Compe 500-C forged alloy side pull brakes, with quick release mechanism for extremely positive braking. Advanced fork design with chrome crown, 27" x 19.6mm alloy rims. Centurion high performance 27" x 250 gram 2.5mm 100 psi skin tires.

Sunshine small flange quick release hubs front and rear. Forged fork end.

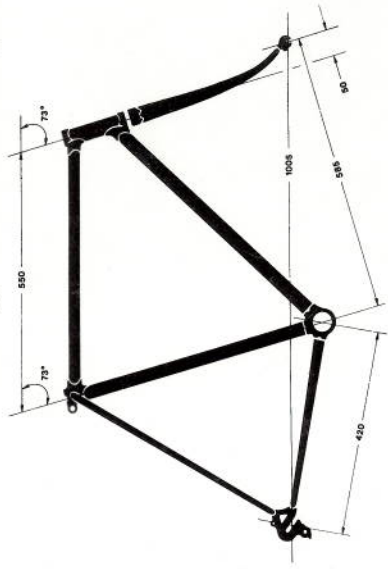

Frame sizes: 21", 23", 25"

Colors: Pearlized Maroon with pinstriping

Pearlized Cobalt Blue with pinstriping



Centurion Super Le Mans

Covering New Ground

Designed for the dual-purpose
enthusiast who wants a highly responsive
12-speed racing machine, yet geared
for touring capabilities.

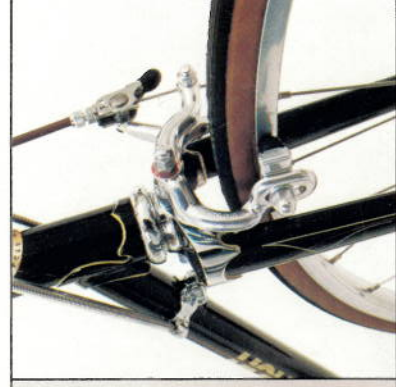

Dia-Compe 500-Q forged alloy side-pull
brakes with quick release mechanism.
Advanced fork design for strength.
Forged crown for racy, good looks.
Centurion 27" 250 gram 25mm 100 psi
skin tires for lightweight roadability.

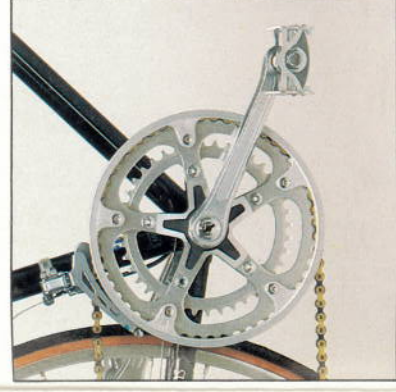

5-arm cotterless alloy cranks with inter-
changeable inner and outer sprockets for
easy gear ratio changes. Professional style
aluminum pedals by MKS.



Forged concave seat stay. Specially
designed seat binder tube with chromoly
allen head binder bolt. Alloy seat post.

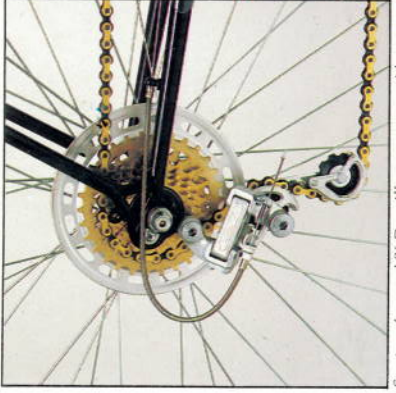

Suntour's new VX Derailleur system with
gold Tran-Z chain and gold 6-speed
freewheel. New cog design is as narrow as
a normal 5-speed. Teeth are sharply tipped
and "zigzagged" to fit each link plate
precisely to enable quick, smooth speed
changes.

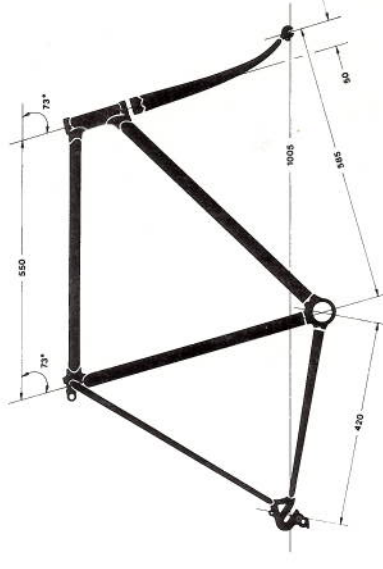

Frame Sizes: 19" 21" 23" 25"

Colors: Gloss Black with pinstriping

Pearlized Silver with pinstriping

Pearlized Maroon with pinstriping



Centurion Le Mans

Standing Alone

Designed for the 12-speed enthusiast who needs enough versatility for short-range touring, occasional long-range touring and day-to-day commuting. Modeled after the Centurion Elite, an exceptional production machine in every detail of design and finish.



Suzue quick release alloy small flange hub. Lightweight, less friction. Forged fork ends for strength.

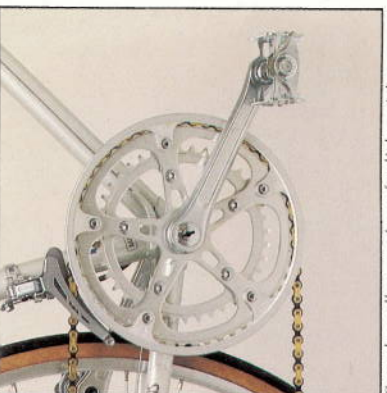

Cotterless alloy crank set for lightweight strength. Butted frame tubes also for lightweight strength. Self-balancing pedals stay in riding position.

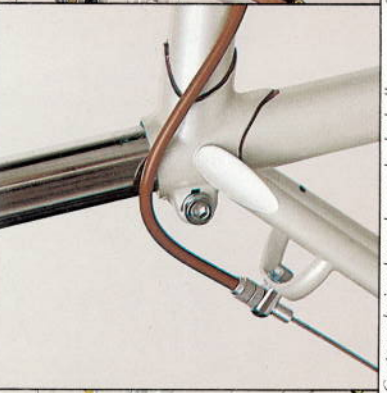

Custom design lug, chromoly dual allen head seat binder bolt for positive locking. Brazed-on rear brake cable hanger for positive adjusting, reduction of cable friction. Forged concave seat stay for strength and European good looks.

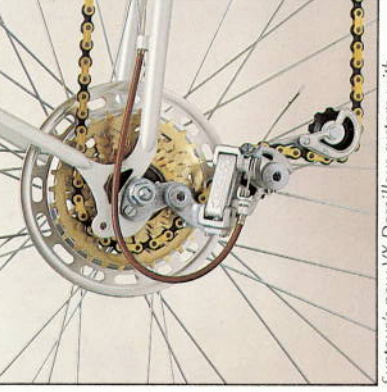

Suntour's new Vx Derailleur system with gold Train-Z chain and gold 6-speed freewheel. New cog design is as narrow as a normal 5-speed. Teeth are sharply tipped and "zigzagged" to fit each link plate precisely to enable quick, smooth speed changes.

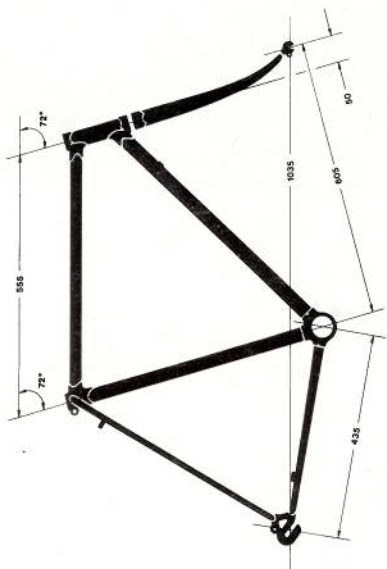

Frame Sizes: 19", 21", 23", 25", 26 3/4"
Colors: Pearlized Silver with pinstripping

- Pearlized Cobalt Blue with pinstripping
- Pearlized Maroon with pinstripping (Men's frame style only)
- Pearlized Rose with pinstripping (Mixte frame style only)



Ladies' Mixte in touring or racing style.
Frame Sizes: 19", 21", 23"



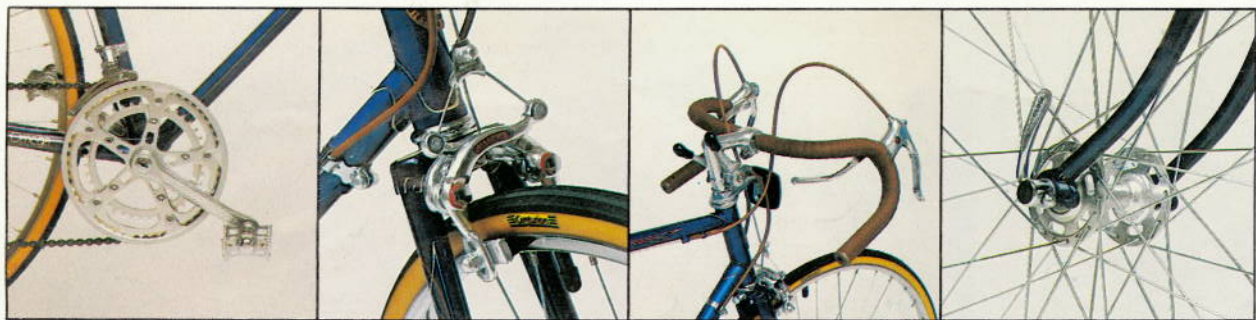

Cotterless alloy crank arms, 5-pin chain rings for lightweight strength. Self-balancing pedals designed for minimal friction.

Dia-Compe forged alloy center pull brakes for positive stopping action. Centurion 85 psi high pressure gumwall tires for roadability.

Convenient dual-position brake levers. Alloy randonneur handlebars for more positions of comfort. Color-coordinated cloth tape. Brazed-on cable guides reduce cable friction.

Quick release forged alloy large flange hub for strength, lightweight and easy wheel removal.



Centurion Omega

Commanding Attention
Designed for the enthusiast who wants the versatility of Centurion's Le Mans, but also needs economy without giving up quality.

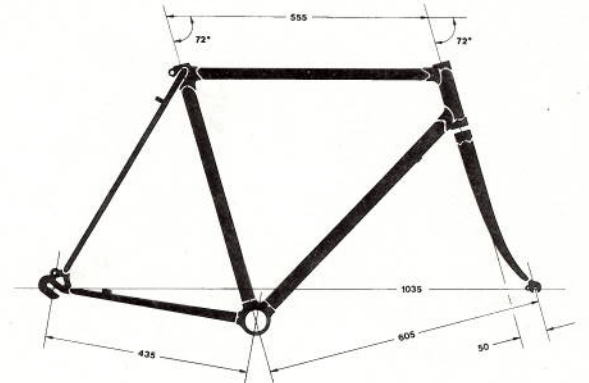

Frame Sizes: Men's 19", 21", 23", 25", and 18" w/26 x 1 1/4 wheels
Colors: Pearlized Silver with pinstriping

- Pearlized Cobalt Blue with pinstriping
- Pearlized Maroon with pinstriping

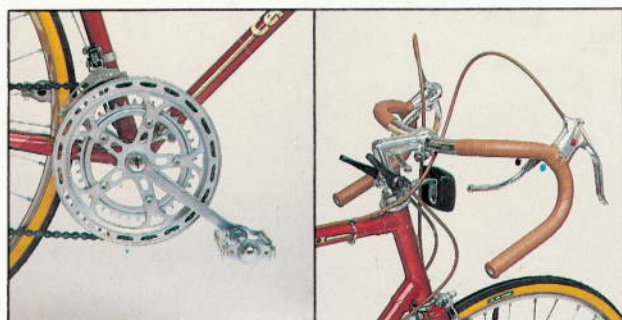

Forged cotterless crank arms with 5-pin rings for added strength.

Convenient dual-position brake levers. Randonneur handlebars for more positions of comfort. Color-coordinated vinyl tape. Stem mounted shift levers.



Centurion Sport DLX

Keeping Command
Designed for the budget-minded enthusiast who demands quality and value in a general-purpose bike.

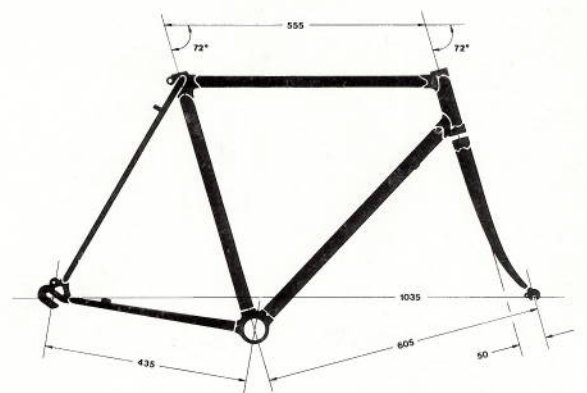

Frame Sizes: Men's 19", 21", 23", 25"; 19" Ladies
Colors: Metallic Red

- Metallic Blue
- Metallic Silver