

DIS
TEVANO

SPECIALITÉS



PRECISION

PRECISION

FINITION

FINISHING

PRESENTATION

GET-UP

INTERCHANGEABILITE

INTERCHANGEABILITY

STANDARDISATION

STANDARDIZATION

STOCK PERMANENT

PERMANENT STOCK

INDEX

PEDALS _____	2-3
HEAD SETS _____	4
AXLES - CUPS FOR CRANKSETS _____	5
3 PINS CRANKSETS - PROFESSIONAL MODEL _____	6-7
5 PINS CRANKSETS - CRITERIUM MODEL _____	8-9
5 PINS CRANKSETS - CYCLOTOURIST MODEL _____	10-11
PROFESSIONAL CRANKSETS _____	12-13
TRACK CHAINWHEELS - CROSS _____	14
TANDEM CRANKSETS _____	15
BAG FOR TYRE _____	16
BAGS - BAG CARRIERS _____	17
BOTTLE CAGES FOR FRAME AND HANDLEBAR _____	18
LIGHT ALLOY BOTTLE CAGES «PLUM» _____	19
CRITERIUM BOTTLE CAGE AND BOTTLE _____	20
BOTTLES - HIP FLASKS _____	21
CLEATS FOR SHOES _____	22
SUNDRIES _____	23
TOOLS _____	24-25



PEDALS

NEW!

ON REQUEST : The pedal cages may be delivered in BLACK CHROMED STEEL.

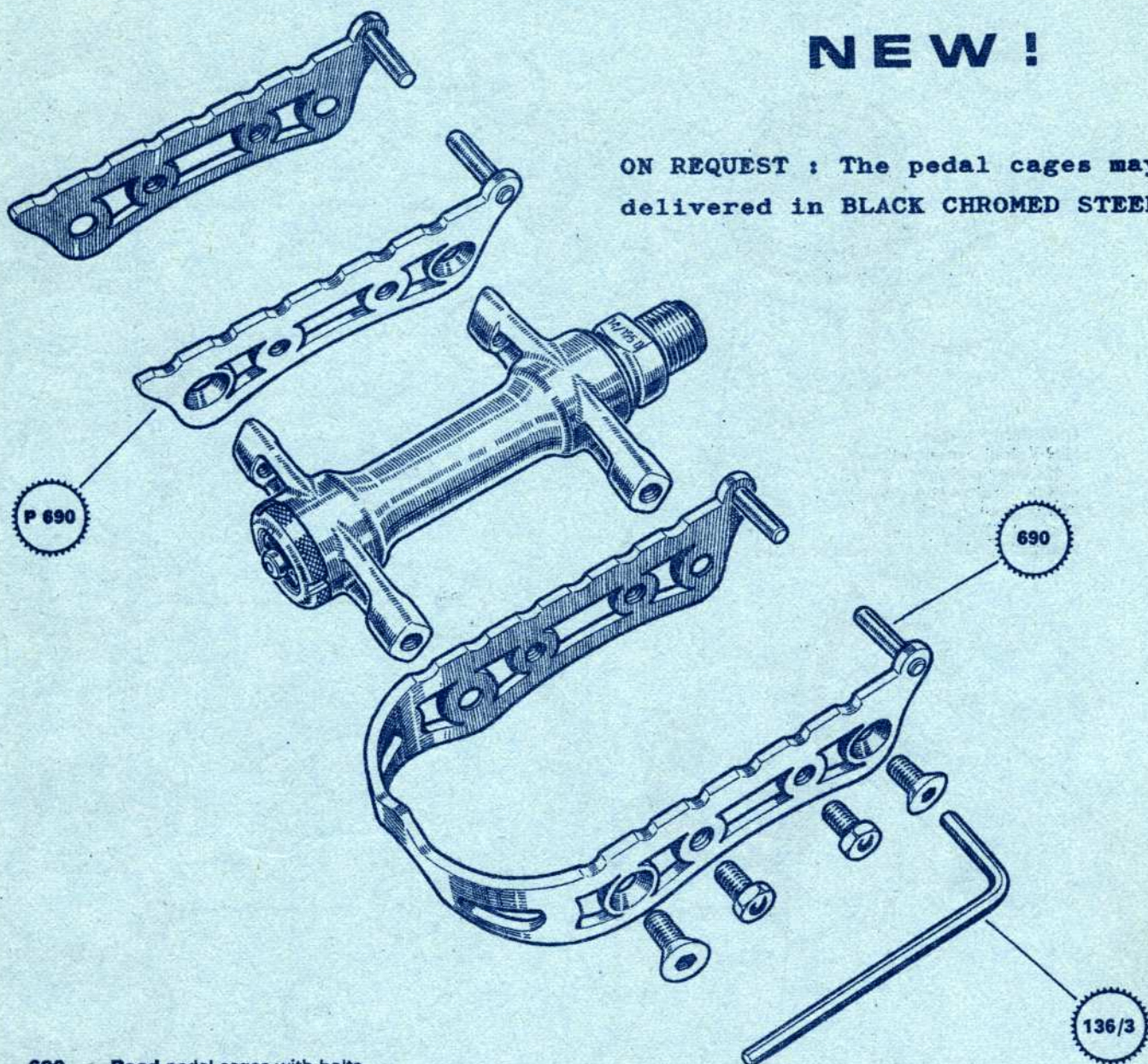

690 Road pedal cages with bolts.
P 690 Track pedal cages with bolts.
136/3 Allen key 3 mm (see tools).

to order tell us: get up (hard anodised or silver)

without special request
we deliver:
hard anodised.

HEAD SET



Ultra light head set.
 High quality manufacture.
 Light alloy parts with
 cup in hard treated steel.
High quality balls ($\varnothing 4.76$)
Get up: black or silver.
Weigh: about 110 grammes with balls.

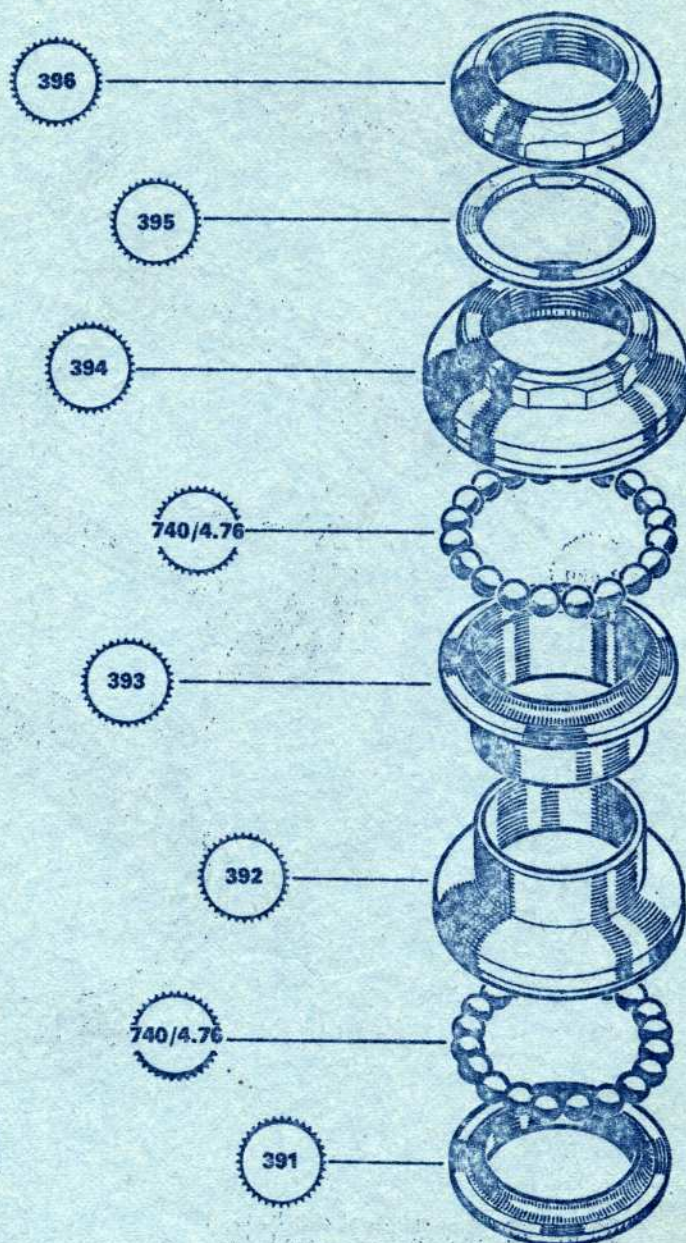

to order tell us: thread ($\varnothing 1'' \times 24 F$ or $\varnothing 25 \times 1$),
 get up (black or silver).

**without special request
 we deliver:**

thread $\varnothing 1'' \times 24 F$, silver anodised.

- 391 Cone fork.
- 392 Lower frame cup.
- 393 Upper frame cup.
- 394 Adjusting cup: (thread $\varnothing 1'' \times 24 F$).
: (thread $\varnothing 25 \times 1$).
- 395 Stop washer
- 396 Look ring: (thread $\varnothing 1'' \times 24 F$).
: (thread $\varnothing 25 \times 1$).
- 740/4.76 Special balls for head set.
- 3900 Head set: (thread $\varnothing 1'' \times 24 F$).
: (thread $\varnothing 25 \times 1$).

AXLES AND CUPS FOR CRANKSET

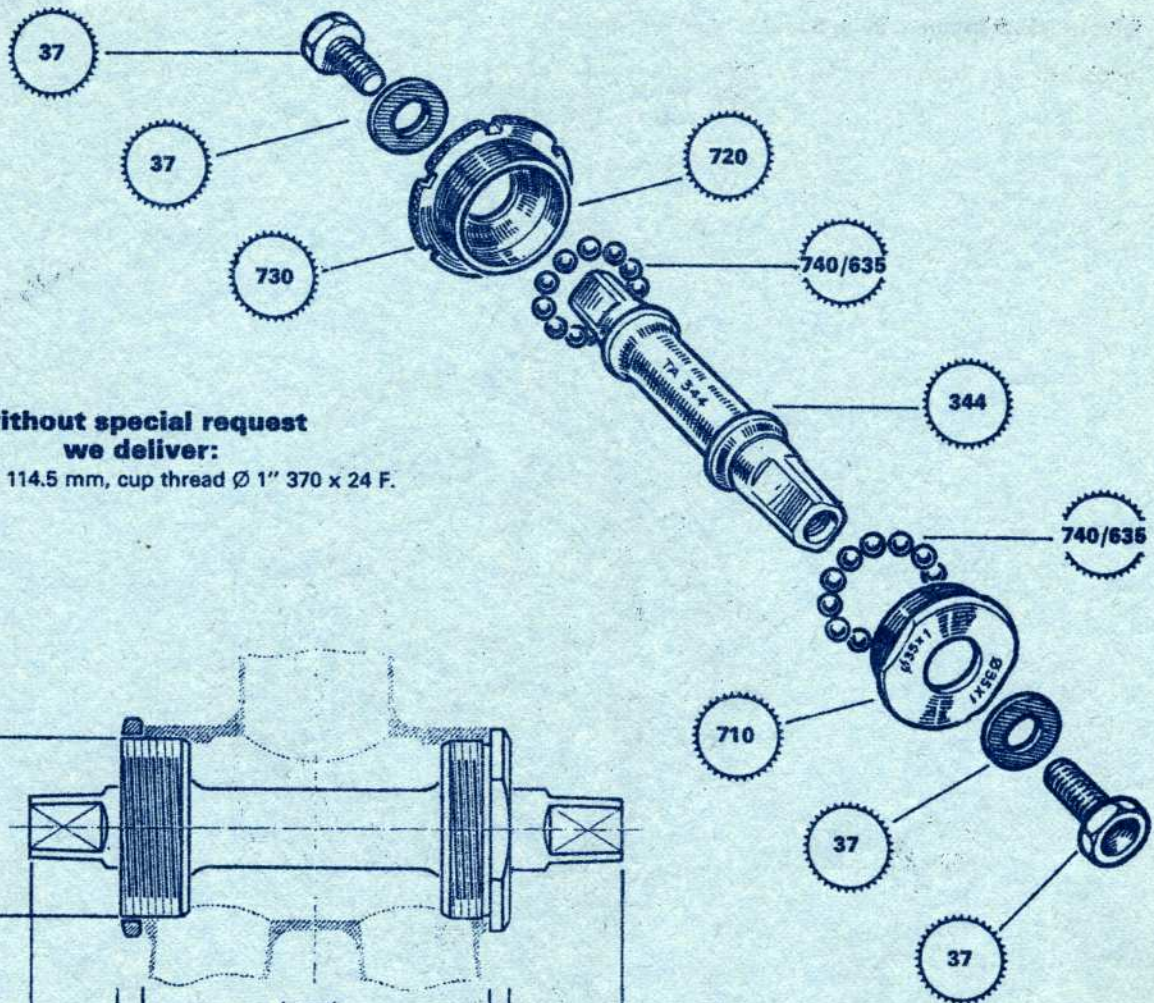

**without special request
we deliver:**
axle length 114.5 mm, cup thread \varnothing 1" 370 x 24 F.

right - left
right - right
right - right

\varnothing 1" 370 x 24 F
 \varnothing 36 x 24 F
 \varnothing 35 x 1

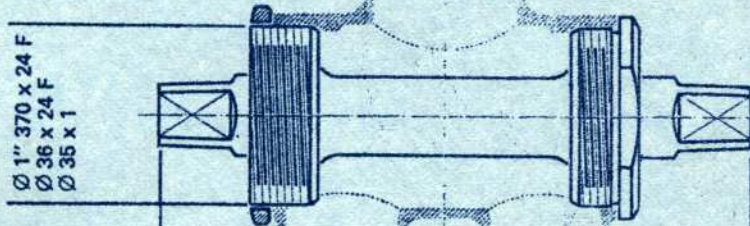

	axle		length box		complete length		
track 1 chainwheel	314	17	4,5	68 - 70	3	19	111,5 mm
2 chainwheels	344	17	4,5	68 - 70	3	22	114,5 mm
road	373	17	4,5	68 - 70	3	25,5	118 mm
3 chainwheels	374	17	4,5	68 - 70	3	29	121,5 mm

- 709 Crankset axle.
- 710 Cup set.
- 710 Stationary cup.
- 720 Adjusting cup.
- 730 Look ring.
- 37 Screws and washers to fix cranks on axle.
- 12 Waterproof plastic box to protect the bearing.
- 740/6.35 Special balls for crankset.

**see above for
thread and length**

to order tell us: axle: length (111.5 or 114.5 or 118 or 121.5).
cups: thread (\varnothing 1" 370 x 24 F or \varnothing 36 x 24 F or \varnothing 35 x 1).

PROFESSIONAL 3 PINS

chainwheels: from 36 to 68 teeth (even and uneven)

cranks: length in mm: 150 - 155 - 160 - 162.5 -
165 - 167.5 - 170 - 172.5 -
175 - 177.5 - 180 - 185

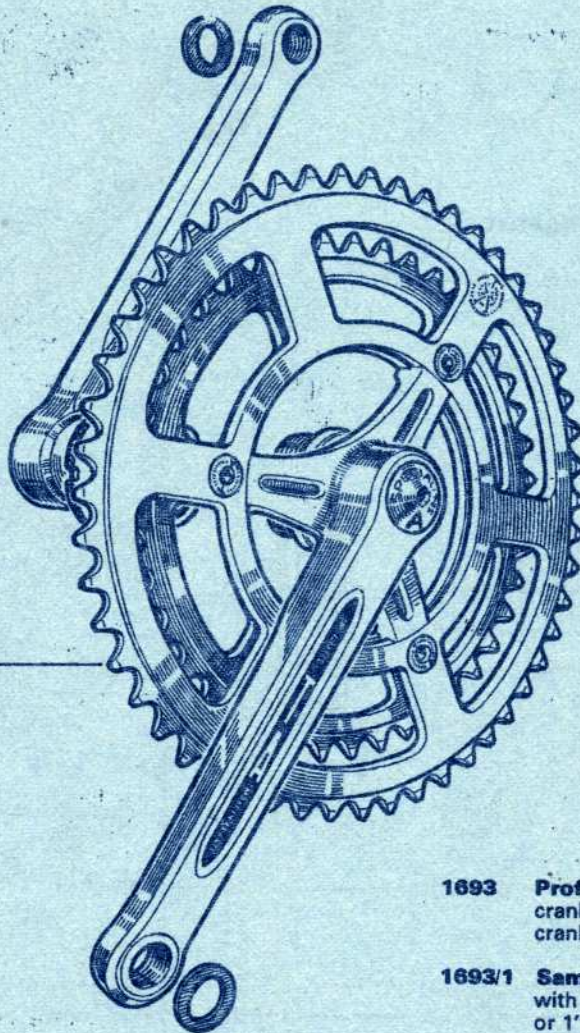

anodised model

1693/2

- 1693** Professional cotterless 3 pins crankset including right and left cranks, BB axle and cups.
- 1693/1** Same as above, type professional, with one chainwheel, chain 1/2 x 3/32 (2.38) or 1" x 1/8 (3.17).
- 1693/2** Same as 1693, type professional, with double chainwheels, chain 1/2 x 3/32 (2.38)
- 1693/3** Same as 1693, type professional, with triple chainwheels, chain 1/2 x 3/32 (2.38)

to order tell us

cranks: length (from 150 to 185 mm).
thread (\varnothing 9/16 x 20 F or \varnothing 14 x 125)
axle: length (111,5 or 114,5 or 118 or 121,5).
cups: thread (\varnothing 1" 370 x 24 F or \varnothing 36 x 24 F or \varnothing 35 x 1)
chainwheels: number of teeth from 36 to 68 (even and uneven).

PROFESSIONAL 3 PINS

anodised model

see specifications
page 5

Axis for crankset.
Stationary cup.
Adjusting cup.
Looking.
Crank fixing screw.
Washer for screw.

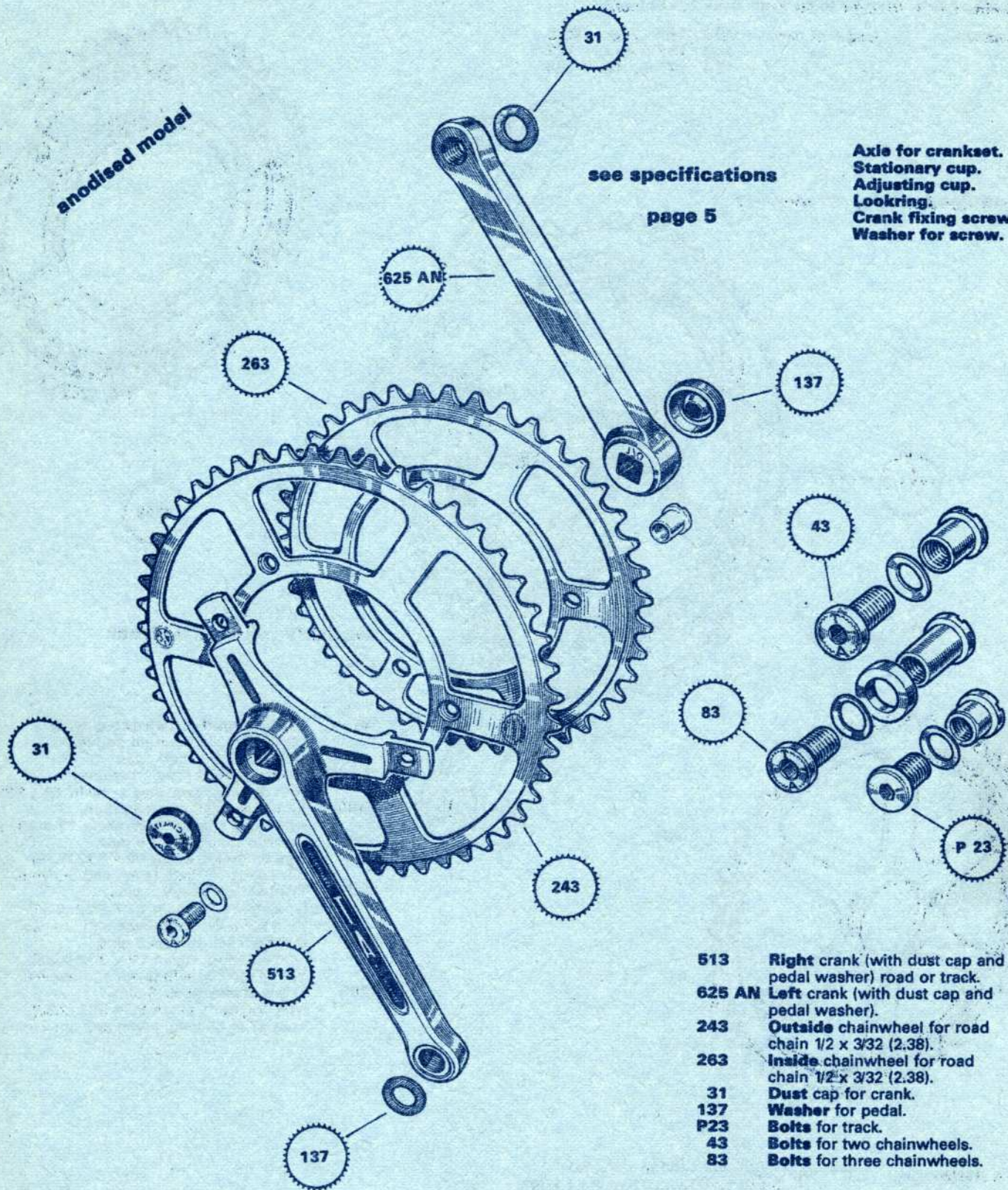

- 513 Right crank (with dust cap and pedal washer) road or track.
- 625 AN Left crank (with dust cap and pedal washer).
- 243 Outside chainwheel for road chain 1/2 x 3/32 (2.38).
- 263 Inside chainwheel for road chain 1/2 x 3/32 (2.38).
- 31 Dust cap for crank.
- 137 Washer for pedal.
- P23 Bolts for track.
- 43 Bolts for two chainwheels.
- 83 Bolts for three chainwheels.

to order tell us: crank thread (\varnothing 9/16 x 20 F or \varnothing 14 x 125).

PROFESSIONAL 5 PINS

chainwheels: from 43 to 68 teeth (even and uneven)

cranks: length in mm: 150 - 155 - 160 - 162.5
165 - 167.5 - 170 - 172.5
175 - 177.5 - 180 - 185

anodised model on request

1690/2

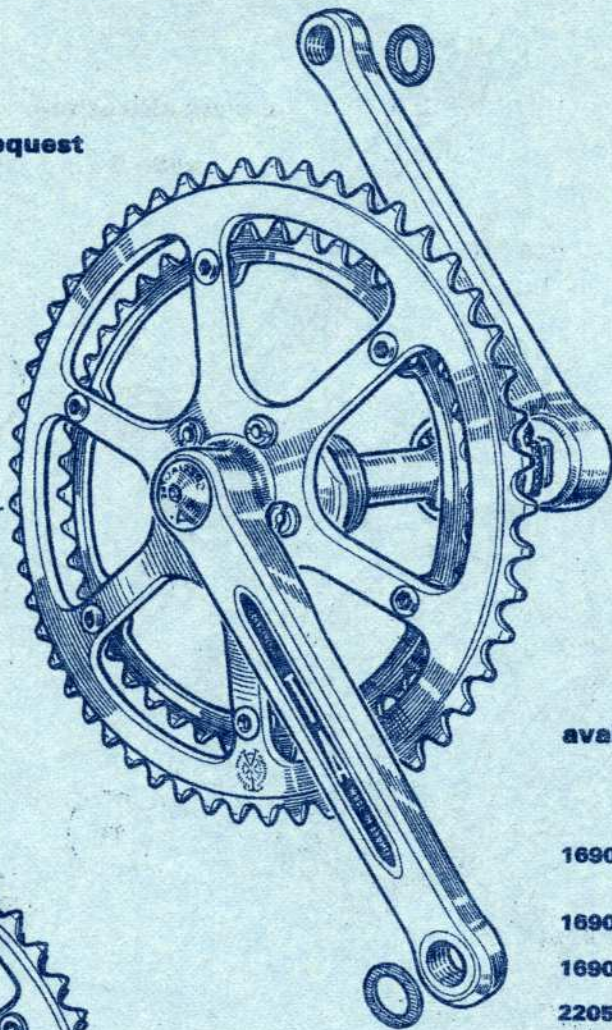

2203

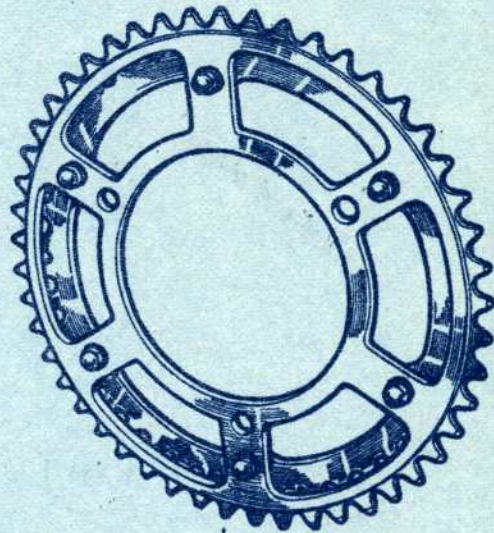

2205

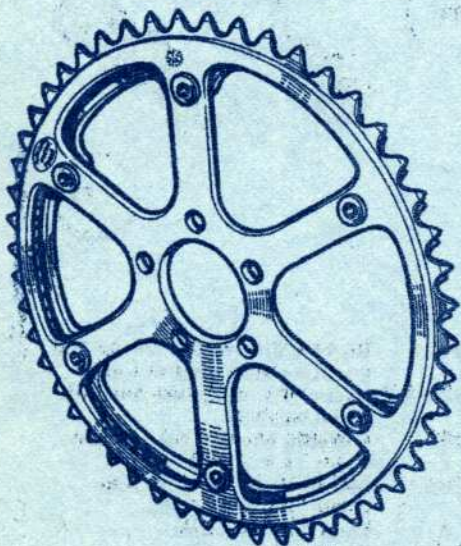

available for road or track.

- 1690** Professional cotterless 5 pins crankset including right and left cranks, BB axle and cups.
- 1690/2** Same as 1690, type criterium, with double chainwheels, chain 1/2 x 3/32 (2.38).
- 1690/3** Same as 1690, type criterium, with triple chainwheels, chain 1/2 x 3/32 (2.38).
- 2205** Double chainwheels 5 pins, type criterium, chain 1/2 x 3/32 (2.38) from 43 to 68 teeth (even and uneven).
- 3205** Triple chainwheels 5 pins, type criterium, chain 1/2 X 3/32 (2.38) from 43 to 68 teeth (even and uneven).
- 2203** Double chainwheels 3 pins, type criterium, chain 1/2 x 3/32 (2.38) from 43 to 68 teeth (even and uneven).
- 3208** Triple chainwheels 3 pins, type criterium, chain 1/2 x 3/32 (2.38) from 43 to 68 teeth (even and uneven).

**to order
tell us**

cranks: length (from 150 to 185 mm).
thread (\varnothing 9/16 x 20 F or \varnothing 14 x 125).
axle: length (111.5 or 114.5 or 118 or 121.5).
cups: thread (\varnothing 1" 370 x 24 F or \varnothing 36 x 24 F or \varnothing 35 x 1).
chainwheels: number of teeth from 43 to 68 (even and uneven).

CRITERIUM model

see specifications

page 5

Axle for crankset.
Stationary cup.
Adjusting cup.
Lockring.
Crank fixing screw.
Washer for screw.

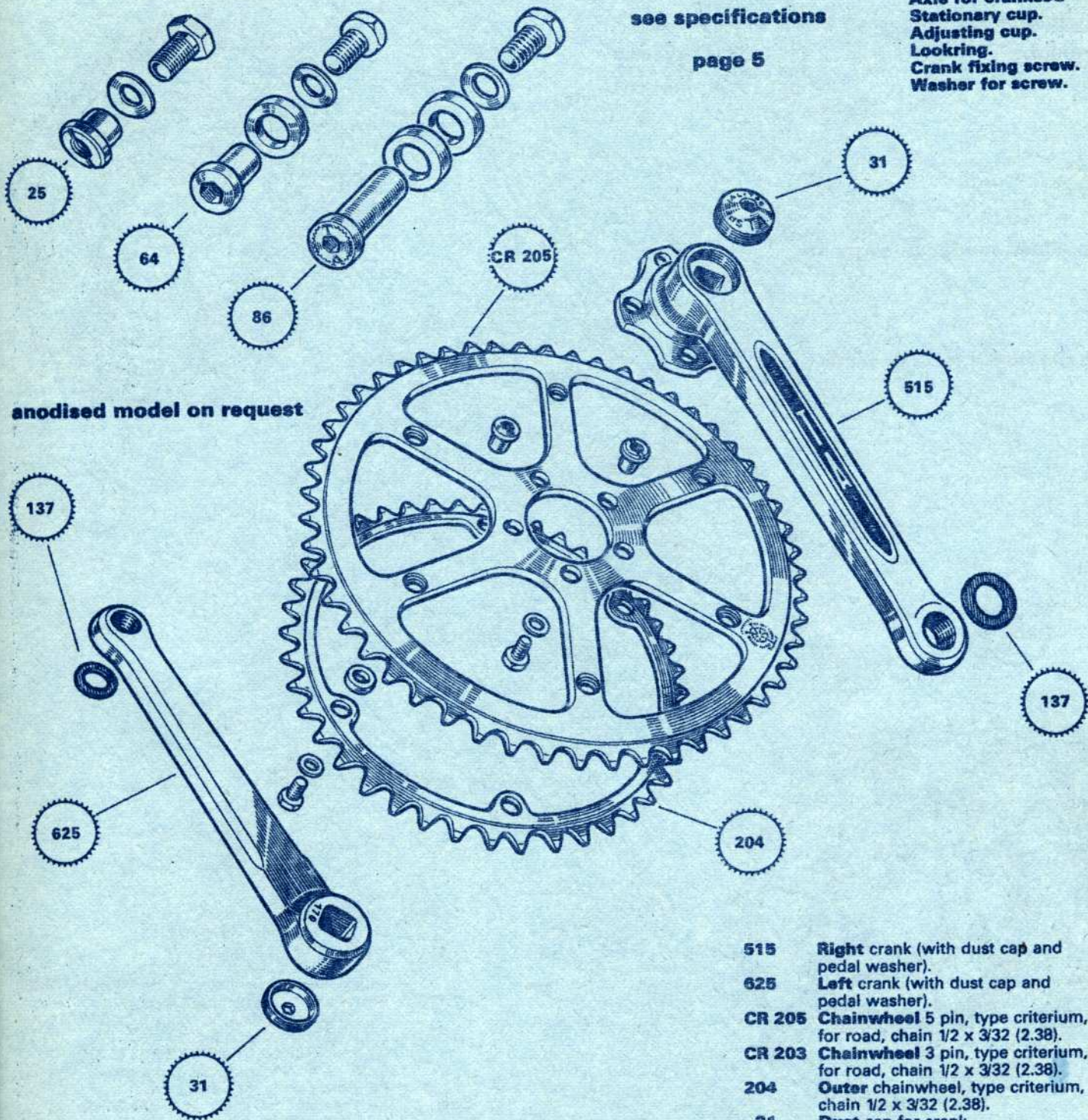

anodised model on request

- 515 **Right crank** (with dust cap and pedal washer).
- 625 **Left crank** (with dust cap and pedal washer).
- CR 205 **Chainwheel** 5 pin, type criterium, for road, chain 1/2 x 3/32 (2.38).
- CR 203 **Chainwheel** 3 pin, type criterium, for road, chain 1/2 x 3/32 (2.38).
- 204 **Outer chainwheel**, type criterium, chain 1/2 x 3/32 (2.38).
- 31 **Dust cap** for crank.
- 137 **Washer** for pedal.
- 64 **Bolts** for double chainwheels.
- 86 **Bolts** for triple chainwheels.
- 25 **Bolts** to fix chainwheels on crank.

to order tell us: crank thread (\varnothing 9/16 x 20 F or \varnothing 14 x 125)-
get up chainwheels and cranks (polished or silver).

chainwheels: from 26 to 68 teeth (even and uneven).

cranks: length in mm: 150 - 155 - 160 - 162.5 - 165 - 167.5 - 170 - 172.5 - 175 - 177.5 - 180 - 185 -

anodised model on request

available for road or track

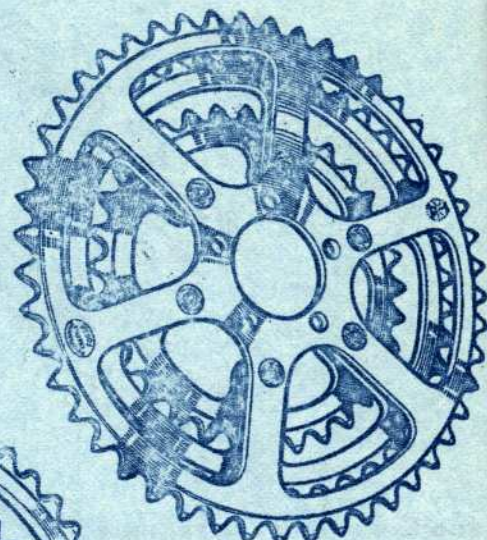

3235

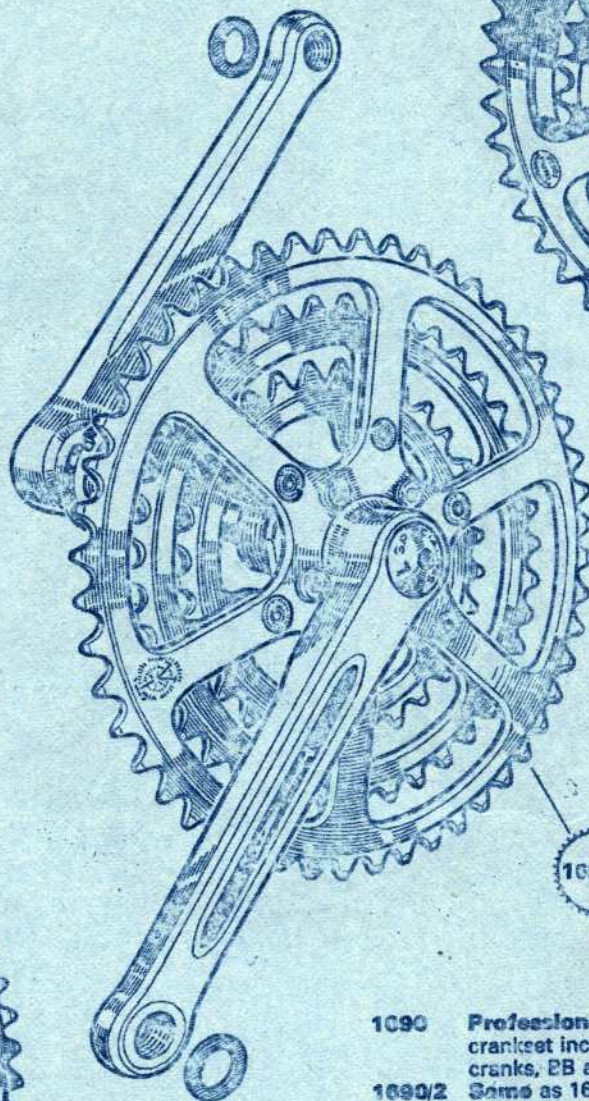

1090/3

2235

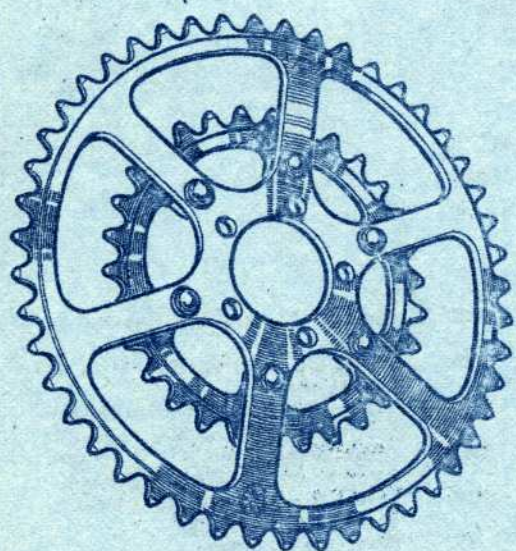

- 1090** Professional cotterless 5 pins crankset including right and left cranks, BB axle and cups.
- 1690/2** Same as 1690, type cyclotourist, with double chainwheels, chain 1/2 x 3/32 (2.38).
- 1690/3** Same as 1690, type cyclotourist, with triple chainwheels, chain 1/2 x 3/32 (2.38).
- 2235** Double chainwheels 5 pins, type cyclotourist, chain 1/2 x 3/32 (2.38), from 26 to 68 teeth (even and uneven).
- 3235** Triple chainwheels 5 pins, type cyclotourist, chain 1/2 x 3/32 (2.38), from 26 to 68 teeth (even and uneven).

**to order
tell us**

cranks: length (from 150 to 185 mm)
thread (Ø 9/16 x 20 F or Ø 14 x 125).
axle: length (111.5 or 114.5 or 119 or 121.5).
cups: thread (Ø 1"370 x 24 F or Ø 36 x 24 F or Ø 35 x 1).
chainwheels: number of teeth from 26 to 68 (even and uneven).

CYCLOTOURIST model

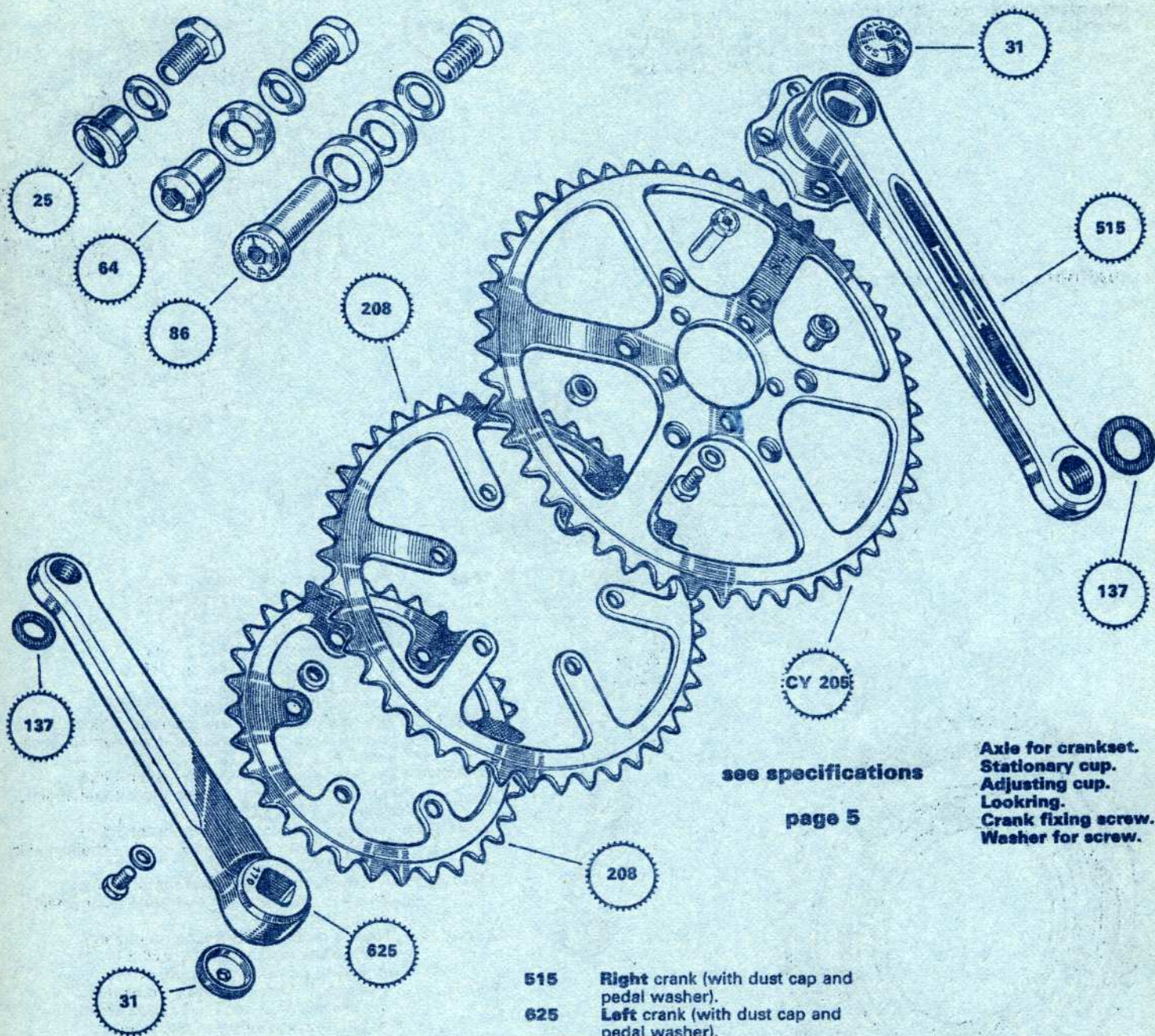

see specifications
page 5

Axle for crankset.
Stationary cup.
Adjusting cup.
Looking.
Crank fixing screw.
Washer for screw.

- 515 Right crank (with dust cap and pedal washer).
- 625 Left crank (with dust cap and pedal washer).
- CY 205 Chainwheel 5 pins, type cyclotourist for road, chain 1/2 x 3/32 (2.38).
- 208 Outer chainwheel, type cyclotourist chain 1/2 x 3/32 (2.38).
- 31 Dust cap for crank.
- 137 Washer for pedal.
- 64 Bolts for double chainwheels.
- 86 Bolts for triple chainwheels.
- 25 Bolts to fix chainwheels on crank.

to order tell us: crank thread (\varnothing 9/16 x 20 F or \varnothing 14 x 125).
get up chainwheels and cranks (polished or silver).

PROFESSIONAL

chainwheels: from 43 to 68 teeth (even and uneven)
cranks: length in mm: 150 - 155 - 160 - 162.5 -
 165 - 167.5 - 170 - 172.5 -
 175 - 177.5 - 180 - 185

available for road or track

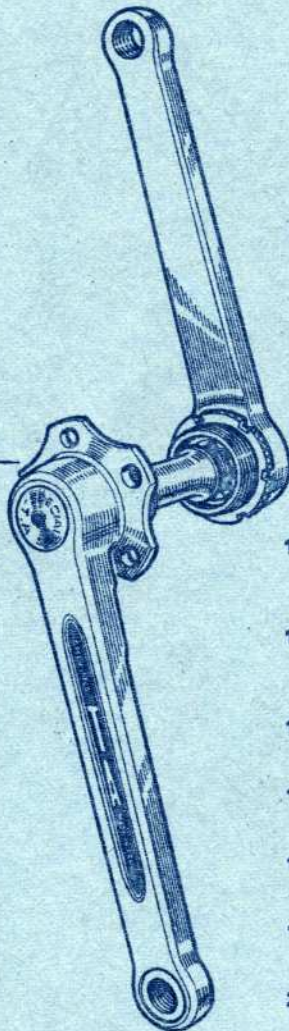
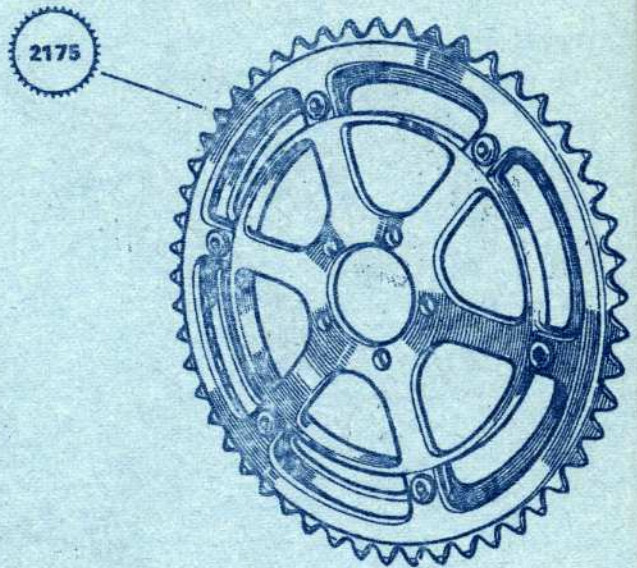

- 1690** Professional cotterless 5 pins crankset including right and left cranks, BB axle and cups. (see specifications page 8).
- 1693** Professional cotterless 3 pins crankset including right and left cranks, BB axle and cups. (see specifications page 6).
- 1690/2175** Professional cotterless crankset 5 pins complete, with adaptor and double chainwheels, chain 1/2 x 3/32 (2.38).
- 1690/3175** Professional cotterless crankset 5 pins complete, with adaptor and triple chainwheels, chain 1/2 x 3/32 (2.38).
- 1690/2173** Professional cotterless crankset 3 pins complete, with adaptor and double chainwheels, chain 1/2 x 1/32 (2.38).
- 1690/3173** Professional cotterless crankset 3 pins complete, with adaptor and triple chainwheels, chain 1/2 X 3/32 (2.38).
- 2175** Double chainwheels 5 pins on adaptor, type professional, chain 1/2 x 3/32 (2.38), from 43 to 68 teeth (even and uneven).
- 3175** Triple chainwheels 5 pins on adaptor, type professional, chain 1/2 x 3/32 (2.38), from 43 to 68 teeth (even and uneven).
- 2173** Double chainwheels 3 pins or adaptor, type professional, chain 1/2 x 3/32 (2.38), from 43 to 68 teeth (even and uneven).
- 3173** Triple chainwheels 3 pins on adaptor, type professional, chain 1/2 x 3/32 (2.38), from 43 to 68 teeth (even and uneven).

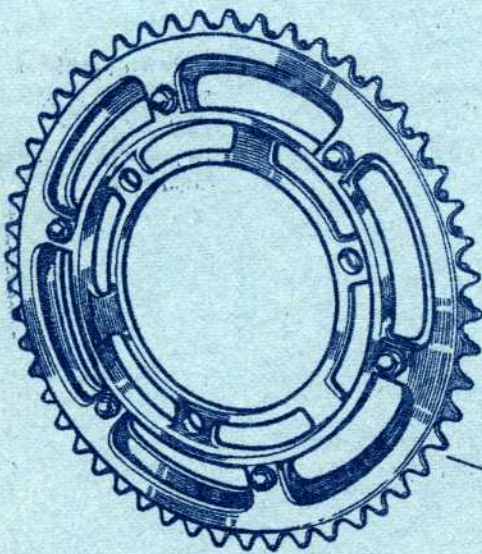

to order
tell us

cranks: length (from 150 to 185 mm) -
 thread (Ø 9/16 x 20 F or Ø 14 x 125).
axle: length (111.5 or 114.5 or 118 or 121.5).
cups: thread (Ø 1"370 x 24 F or Ø 36 x 24 F or Ø 35 x 1).
chainwheels: number of teeth from 43 to 68 (even and uneven).

PROFESSIONAL

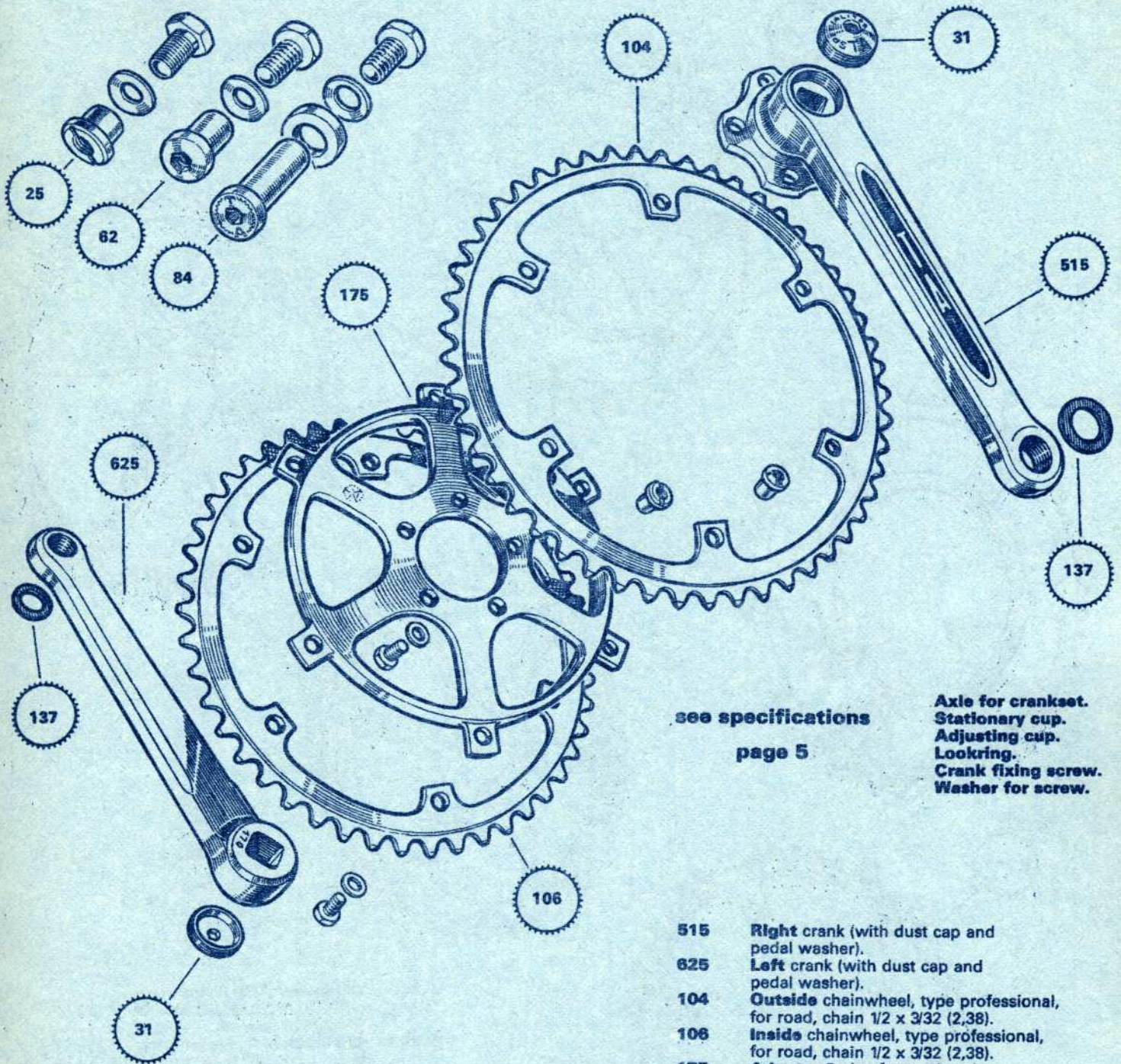

see specifications
page 5

Axle for crankset.
Stationary cup.
Adjusting cup.
Lockring.
Crank fixing screw.
Washer for screw.

- 515 Right crank (with dust cap and pedal washer).
- 625 Left crank (with dust cap and pedal washer).
- 104 Outside chainwheel, type professional, for road, chain 1/2 x 3/32 (2,38).
- 106 Inside chainwheel, type professional, for road, chain 1/2 x 3/32 (2,38).
- 175 Adaptor 5 pins for road.
- 173 Adaptor 3 pins for road.
- 31 Dust cap for crank.
- 137 Washer for pedal.
- 62 Bolts for double chainwheels.
- 84 Bolts for triple chainwheels.
- 25 Bolts to fix chainwheels on crank.

to order tell us: cranks thread (\varnothing 9/16 x 20 F or \varnothing 14 x 125)

SINGLE CHAINWHEELS

P 1755

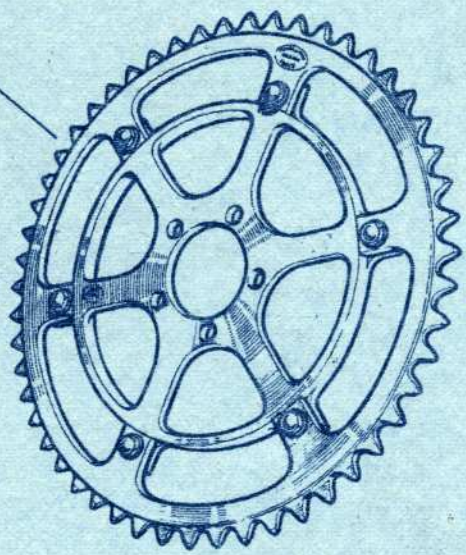

P 205

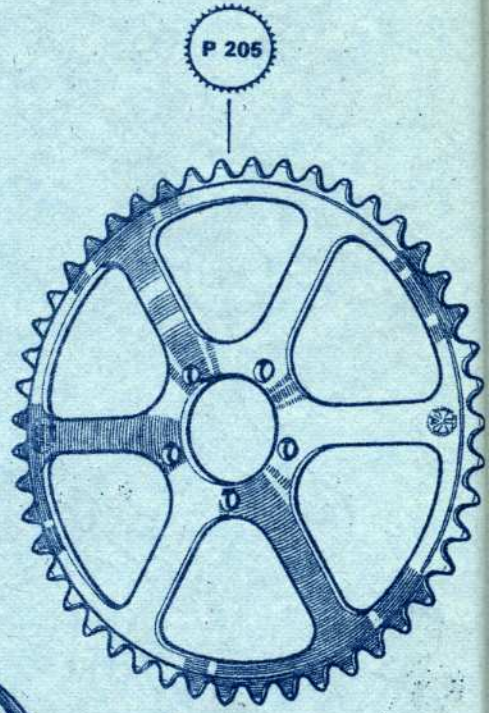

P 203

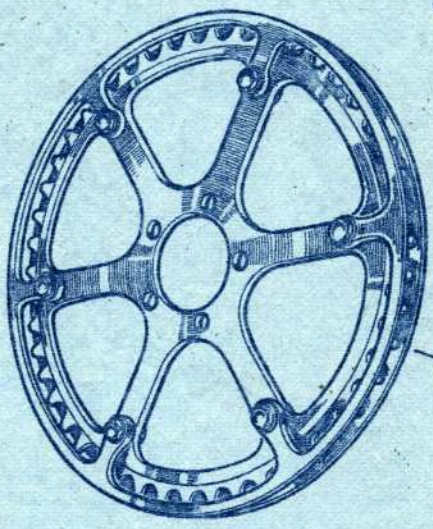
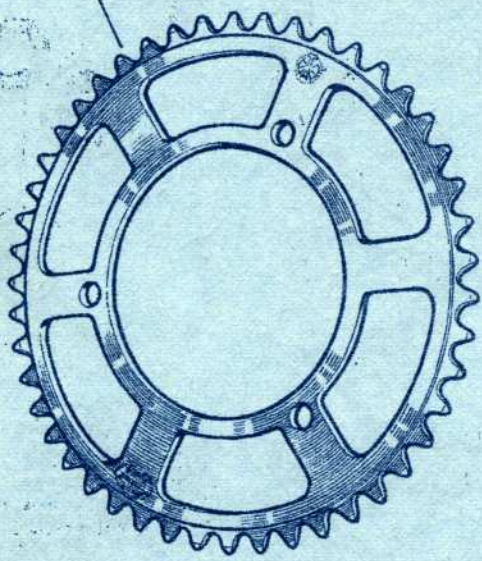

1205

P 209

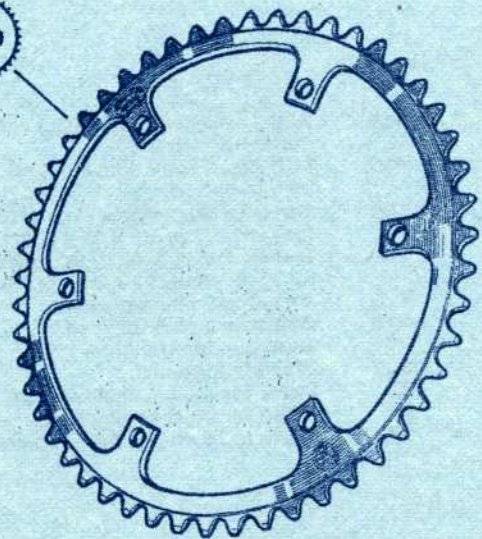

- P 205** Chainwheel 5 pins for track.
chain $\frac{1}{2} \times \frac{3}{32}$ (2.38) or $1'' \times \frac{1}{8}$ (3.17),
from 26 to 68 teeth.
- P 203** Chainwheel 3 pins for track.
chain $\frac{1}{2} \times \frac{3}{32}$ (2.38) or $1'' \times \frac{1}{8}$ (3.17),
from 36 to 68 teeth.
- P 1755** Chainwheel on adaptor 5 pins for track.
chain $\frac{1}{2} \times \frac{3}{32}$ (2.38) or $1'' \times \frac{1}{8}$ (3.17),
from 43 to 68 teeth.
- P 175** Adaptor 5 pins for track.
- P 209** Chainwheel adaptor for track.
chain $\frac{1}{2} \times \frac{3}{32}$ (2.38) or $1'' \times \frac{1}{8}$ (3.17),
from 43 to 68 teeth.
- P 75** Bolts adaptor for track.
- 1205** Chainwheel cyclo cross, type professional,
5 pins, fixed with chain guard,
chain $\frac{1}{2} \times \frac{3}{32}$ (2.38) from 43 to 52 teeth.

TANDEM CRANKSETS

available only in 5 pins professional cranksets

chainwheels: from 26 to 68 teeth (even and uneven).

cranks: length 165 and 170.

stronger chainwheels special for tandem.
chain 1/2 x 3/32 (2.38), from 42 teeth.

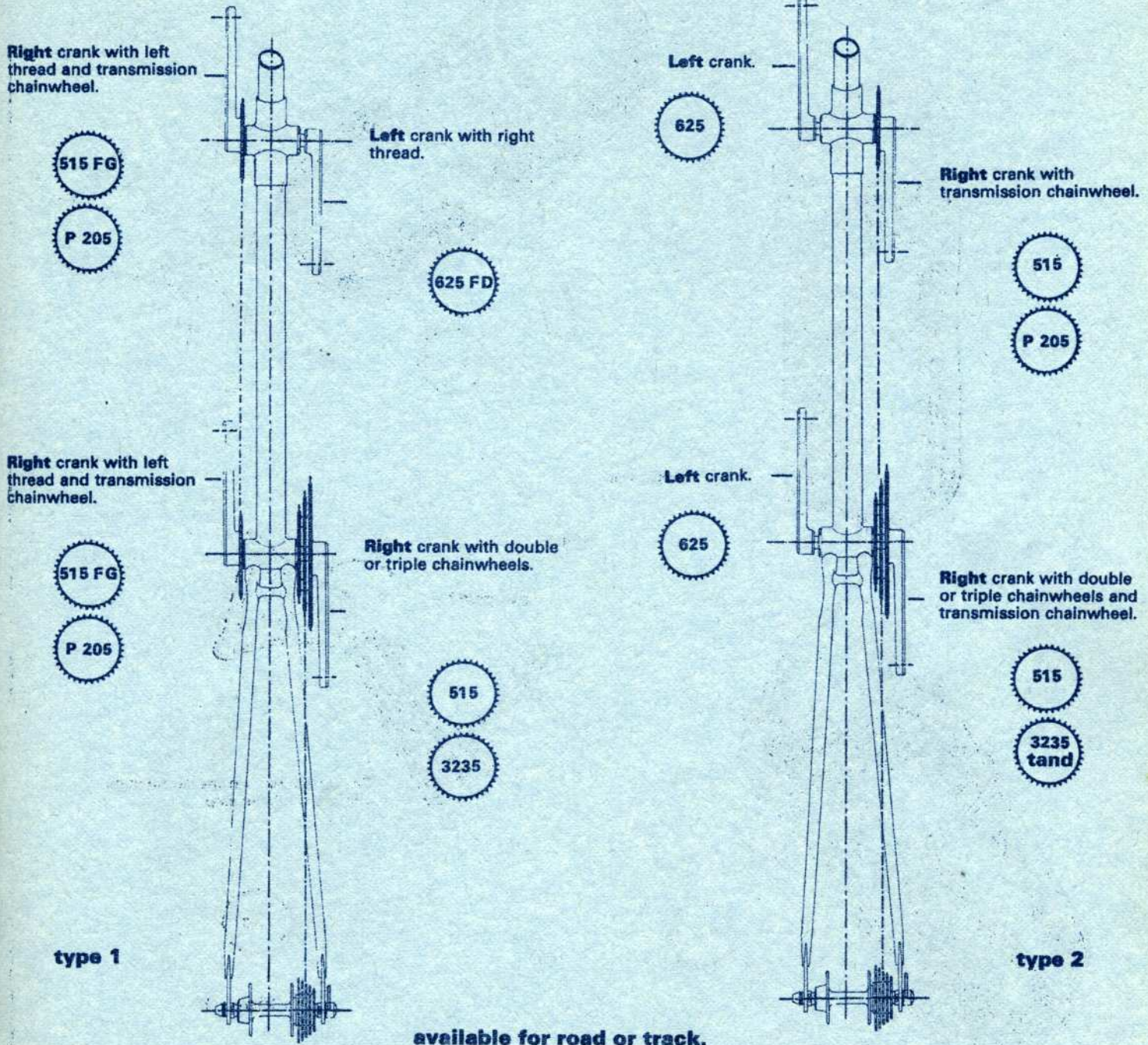

to order tell us

tandem cranksets: type 1 or type 2.
cranks: length (165 and 170 mm).
 thread (Ø 9/16 x 20 F or Ø 14 x 125).
chainwheels: double or triple, number of teeth from 26 to 68 (even and uneven).

new

273

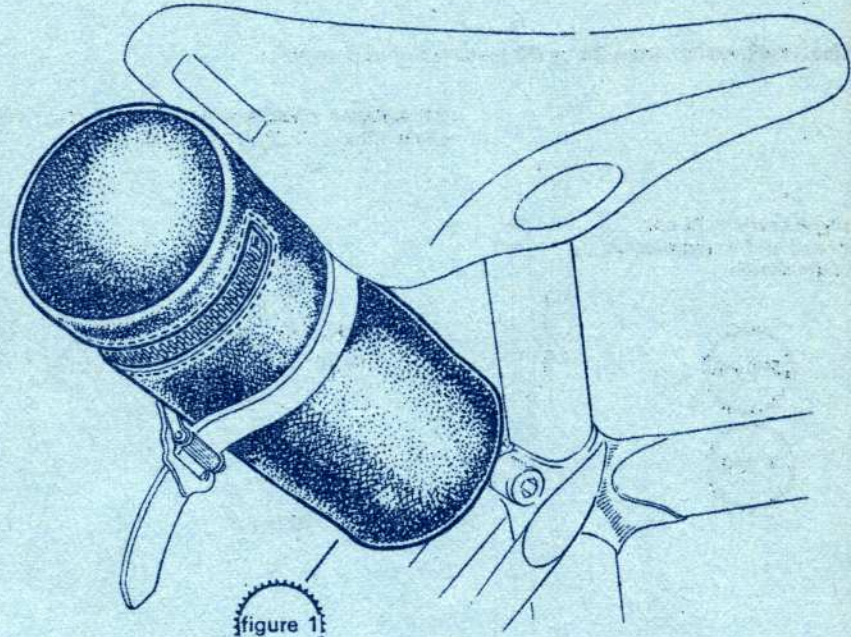

figure 1

rational

light

elegant



figure 2

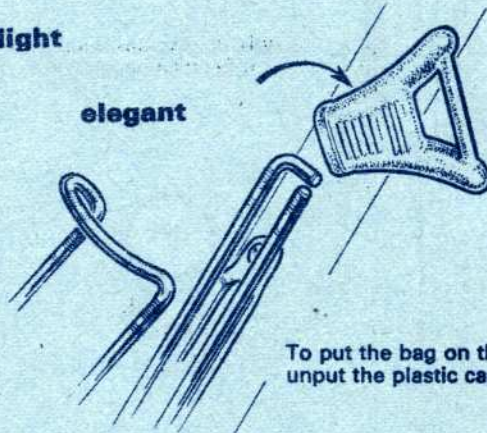

To put the bag on the bottle cage, unput the plastic cap.

273

Packing: 10

273 Bag for tyre, to put behind the saddle or into the bottle cage.

BAGS AND BAGS CARRIER

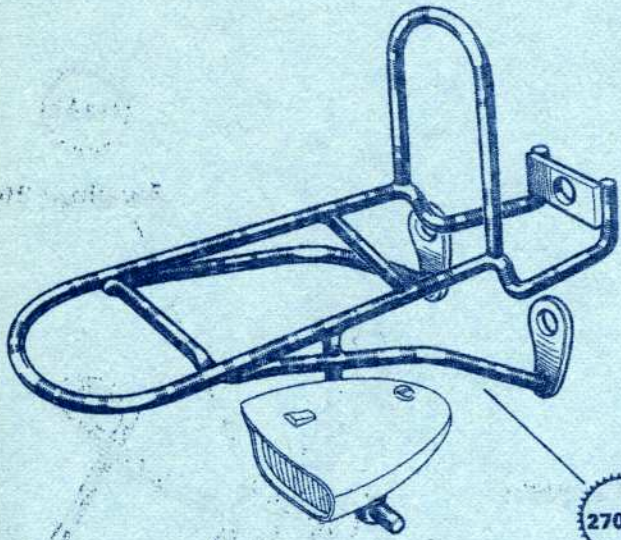

270 PL

Packing: 10

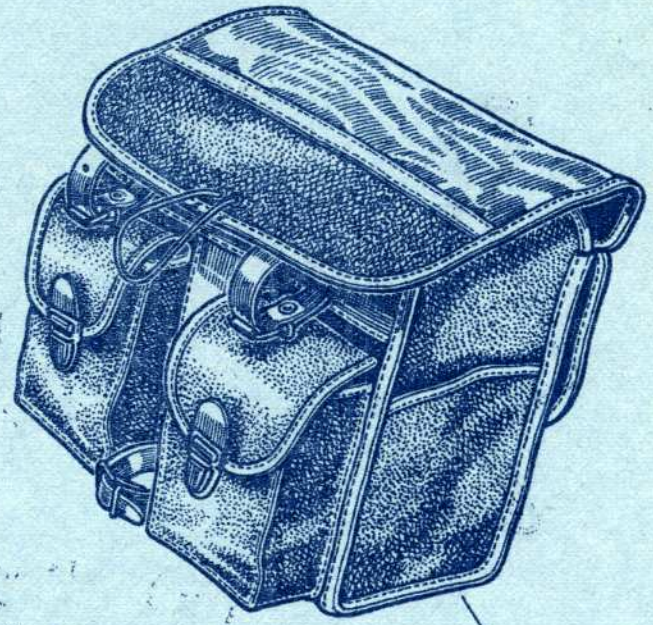

272

271



270

Packing: 10

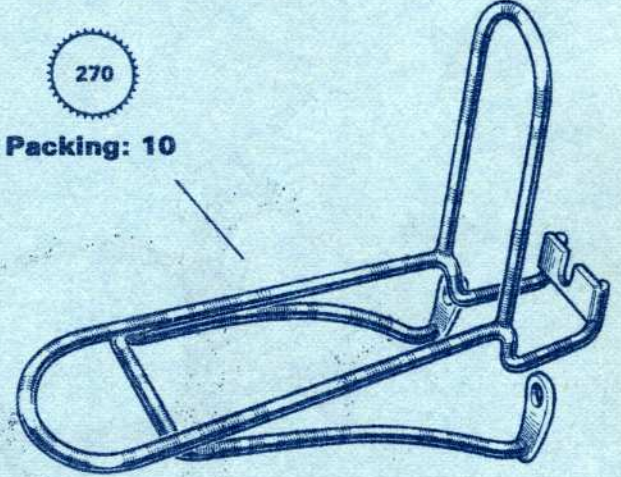

- 270 Front bag carrier in steel for MAFAC brakes, type competition.
- 270 PL Front bag carrier, same model as above with light support.
- 271 Training bag to be fitted on front carrier or handlebar.
- 272 Bag for the handlebar, beautiful finish, transparent card case, pockets on all side.
Get up: waterproof linen or nylon.

BOTTLE-CAGE FOR FRAME AND HANDLEBAR STEEL

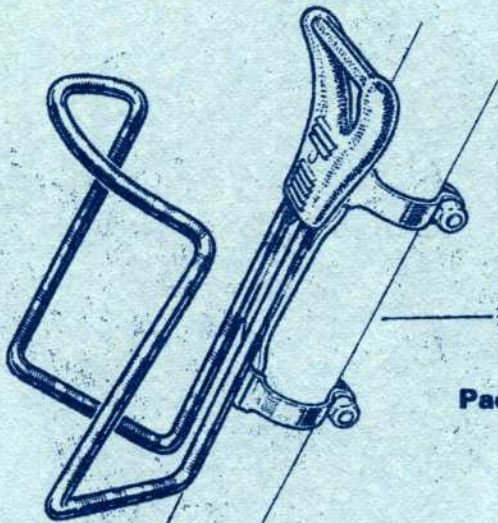

215

Packing: 20

215 AB

Packing: 20

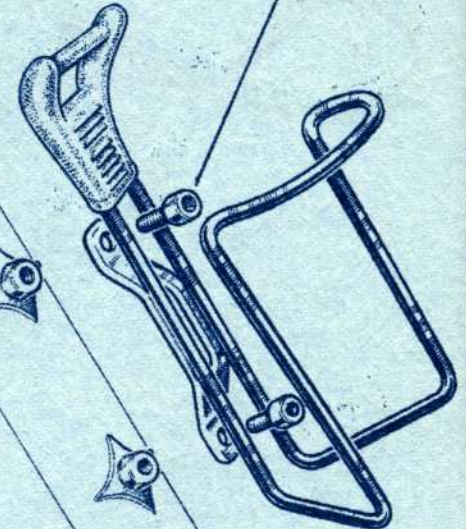

without special request
we deliver:
fix on the frame: with collars.

15



213

Packing: 10

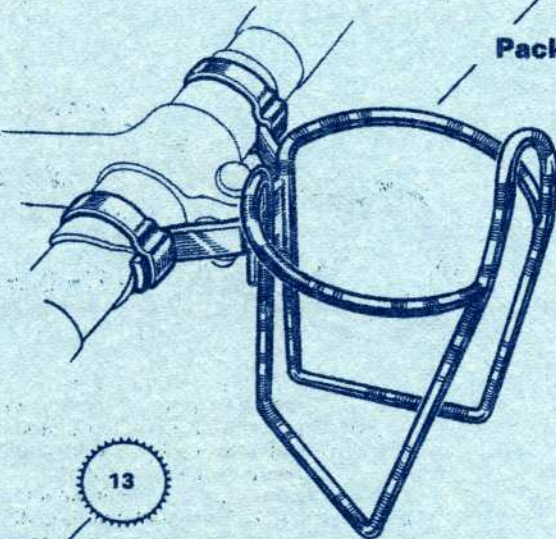

13



- 215 **Bottle-cage**, professional model, in steel to fix on the frame, high with collars.
- 215 AB **Bottle-cage**, same as 215 but with brazed on terminals.
- 215 NU **Bottle-cage**, same as 215 without collars, and without brazed on terminals.
- 15 **Set of collars** for bottle-cage professional model.
- 213 **Handlebar bottle-cage**, professional model, to fix with collars.
- 13 **Set of collars** for handlebar bottle-cage, professional model.

BOTTLE-CAGE model «PLUM» ALUMINIUM

on many racer teams:

GITANE
MERCIER
PEUGEOT
LEJEUNE
TI-RALEIGH
FIAT
ect...

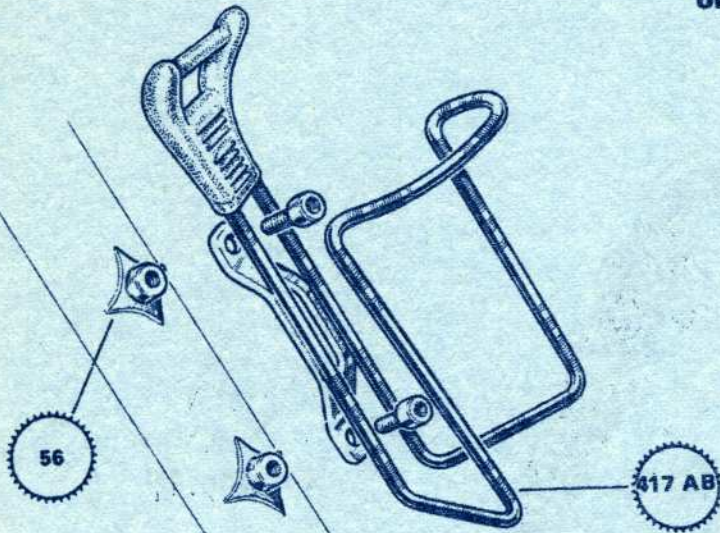

Packing: 10

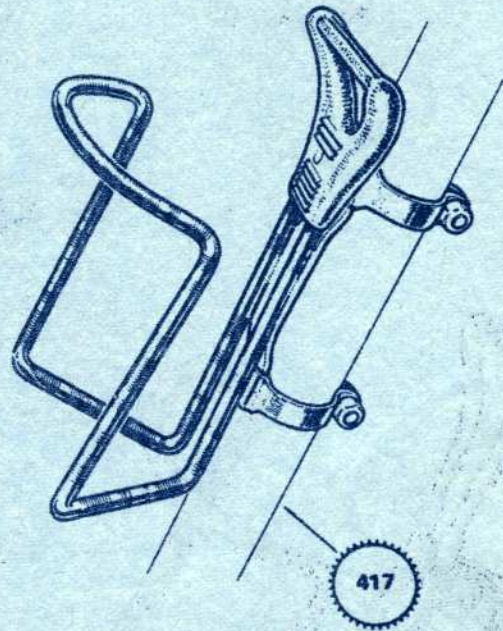

Packing: 10

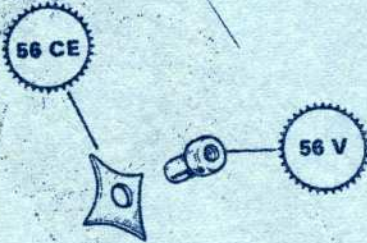

Packing: 10

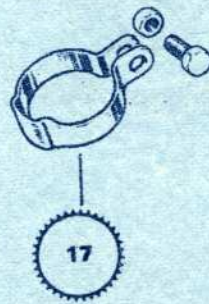

17

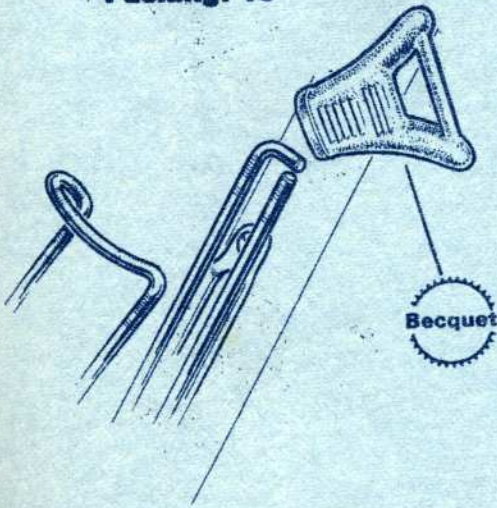

Becquet

- 417 Bottle-cage, model «Plum» in aluminium, to fix on the frame with collars.
 - 417 AB Bottle-cage, same as 417 but with brazed on terminals.
 - 417 NU Bottle-cage, same as 417 but without collars, and without brazed on terminals.
 - 17 Set of collars for bottle-cage model «plum».
 - 56 Set of brazed on terminals.
 - 56 CE Chimney and star.
 - 56 V Chromed screw.
- Becquet for bottle-cage white, black or golden.

without special request
we deliver:

fix on the frame: with collars.
get up: silver.

to order tell us: get up (black or silver).

CRITERIUM BOTTLE AND CAGE

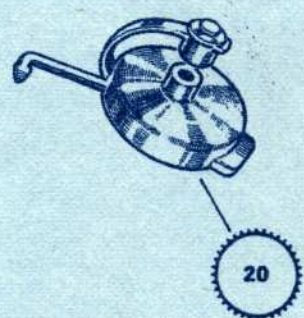
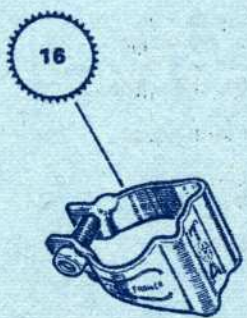
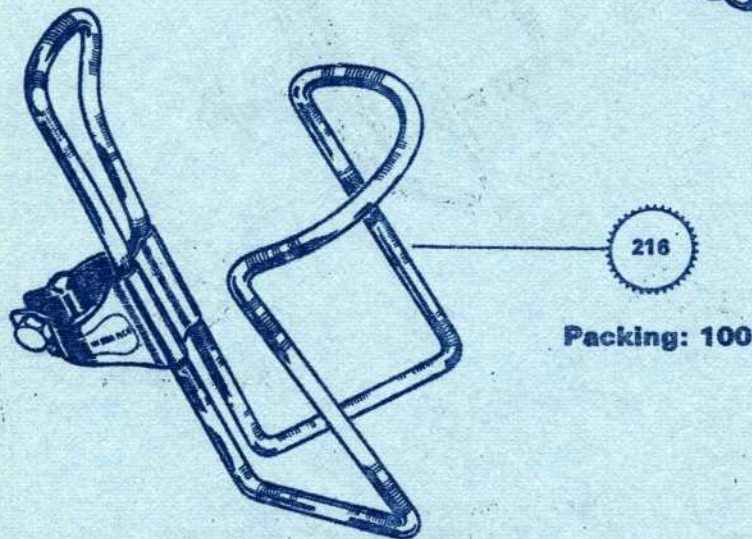
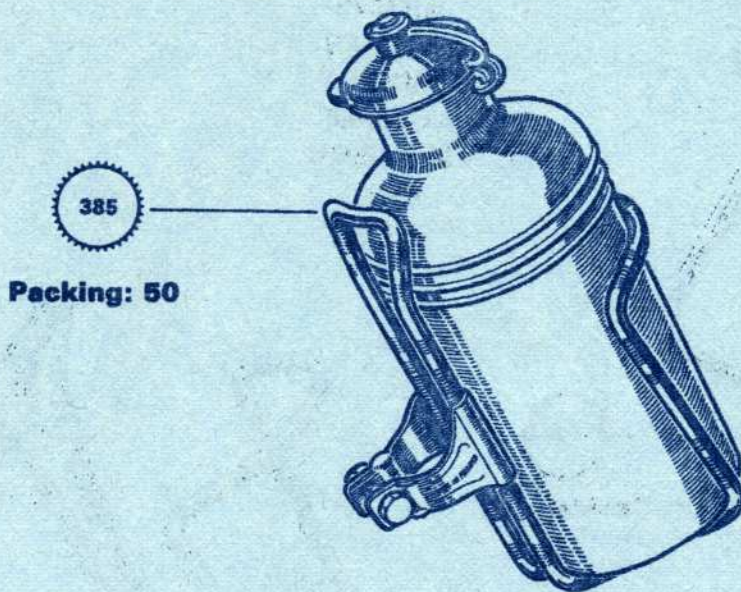

- 385 Special export set, including the bottle and the cage, criterium model.
- 216 Bottle-cage, criterium model, made in steel for fixing on the frame, with collar.
- 16 Steel collar to fix the cage on the frame.
- 197 Bottle white, criterium model, without impress with cap, capacity 60 cl.
- 20 Cap, criterium model.

BOTTLES AND HIP-FLASKS



200

official supplier of «Tour de France»



177



202

Packing: 10

147



21

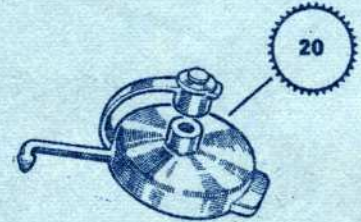

20



300



03



05



150

- 200 Professional model bottle, with two colour impress and breveted cap, capacity 60 cl.
- 202 Tour de France bottle, with two colour impress and breveted cap, capacity 65 cl.
- 147 Isol bottle, keep warm or cool, with breveted cap, capacity 50 cl.
- 177 Protection for bottle, model «special Tour de France» keep warm or cool, design.
- 300 Hip-Flask of 30 cl.
- 150 Hip-flask of 15 cl.
- 21 Breveted cap.
- 20 Cap criterium
- 03 Cork for hip-flask of 300.
- 05 Cork for hip-flask of 150.

SHOE - PLATES

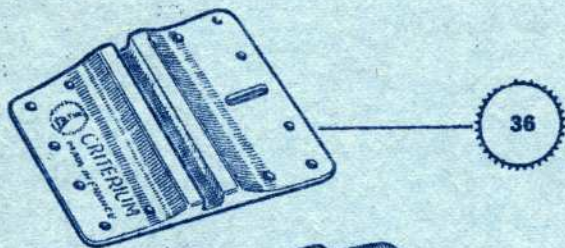

36

36 Shoe - plate, model criterium, treated light alloy delivered with hobnails.

Packing: 25 pairs

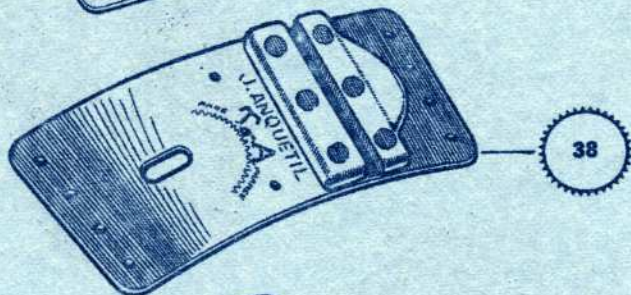

38

38 Shoe - plate, model Anquetil road, small plate in light alloy protected by a steel stiffener, fitted by copper rivets, delivered with hobnails.

Packing: 25 pairs

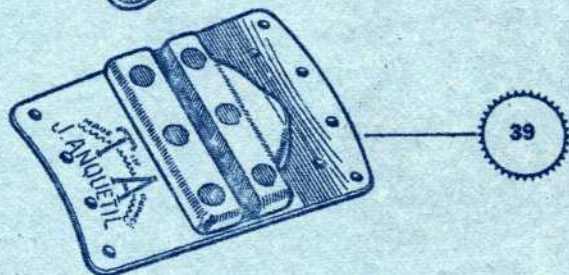

39

39 Shoe - plate, model Anquetil track, small plate in light alloy protected by a steel stiffener, fitted by copper rivets, delivered with hobnails.

Packing: 25 pairs

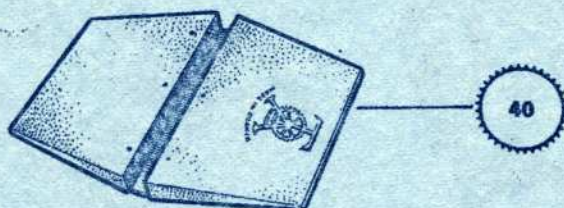

40

40 Shoe - plate, model leather, first quality leather small plate, steel support, delivered with hobnails.

Packing: 20 pairs

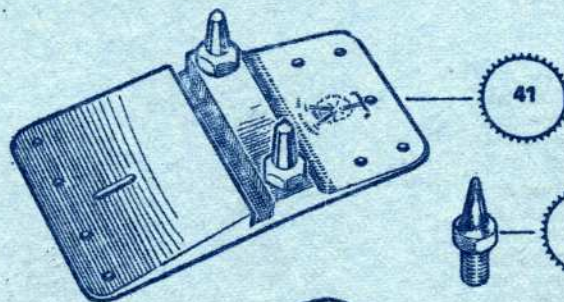

41

41 Shoe - plate, model cross, treated light alloy, delivered with 4 tacks and hobnails.

Packing: 20 pairs



27

27 Tacks only for shoe - plate.

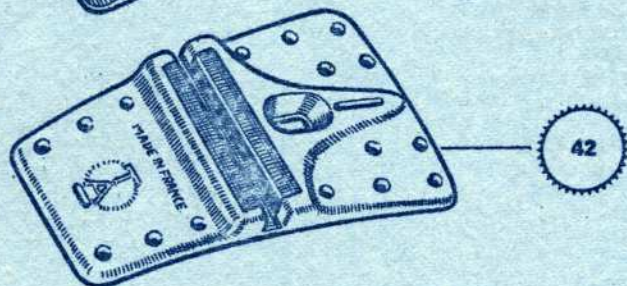

42

42 Shoe - plate, model calrouge, adjustable, curved, ultra light, plastic material, delivered with hobnails.

Packing: 20 pairs

SUNDRIES

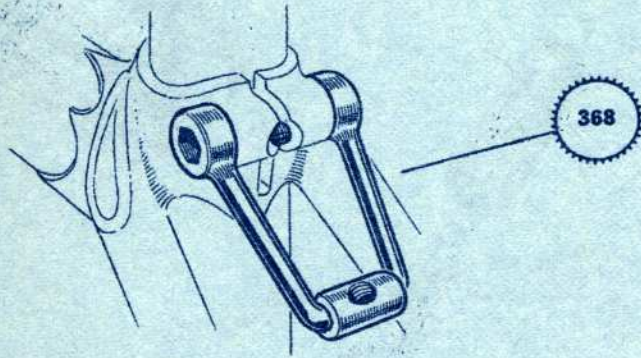

368 Seat bolts with cable guide.

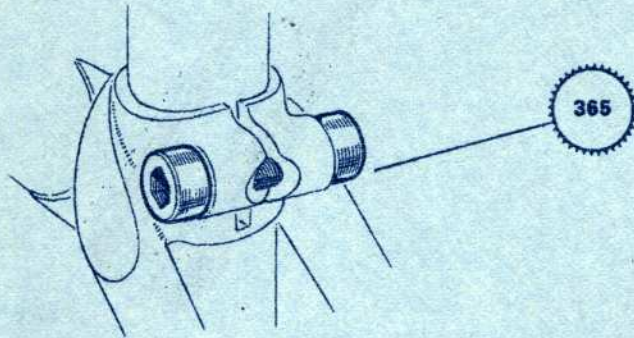

365 Seat bolts in chromed steel.

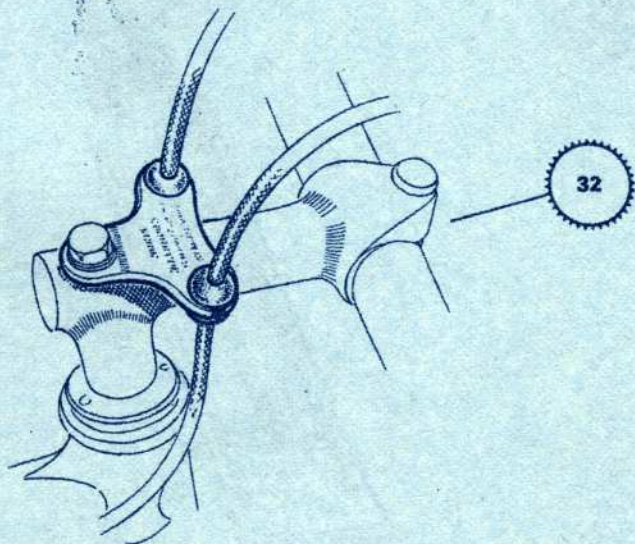

32 Guid'gaine identity.

TOOLS

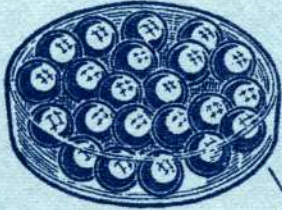
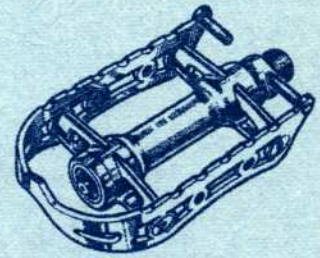
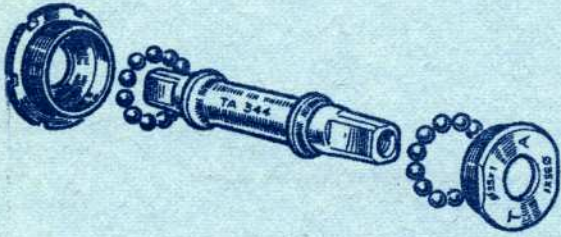

740/6.35

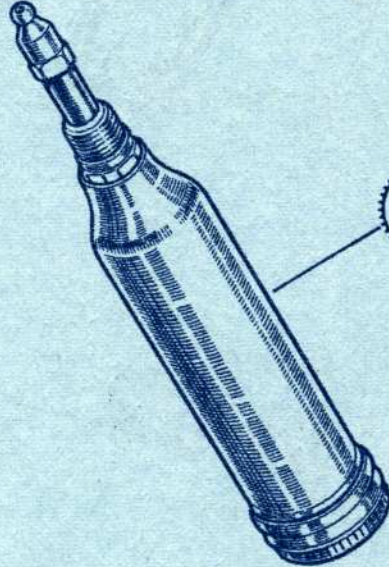

251



740/4.76



740/3.96

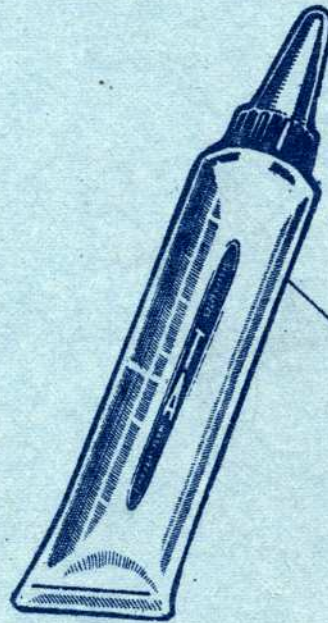

114

- 114 250 grammes special grease tube.
- 251 Grease pump special pedals.
- 740/6.35 Precision balls Ø6.35, special for crankset, in box of 22 balls.
- 740/4.76 Precision balls Ø4.76, special for head sets, in box of 42 balls.
- 740/3.96 Precision balls Ø3.96, special for head sets, in box of 48 balls.

TOOLS

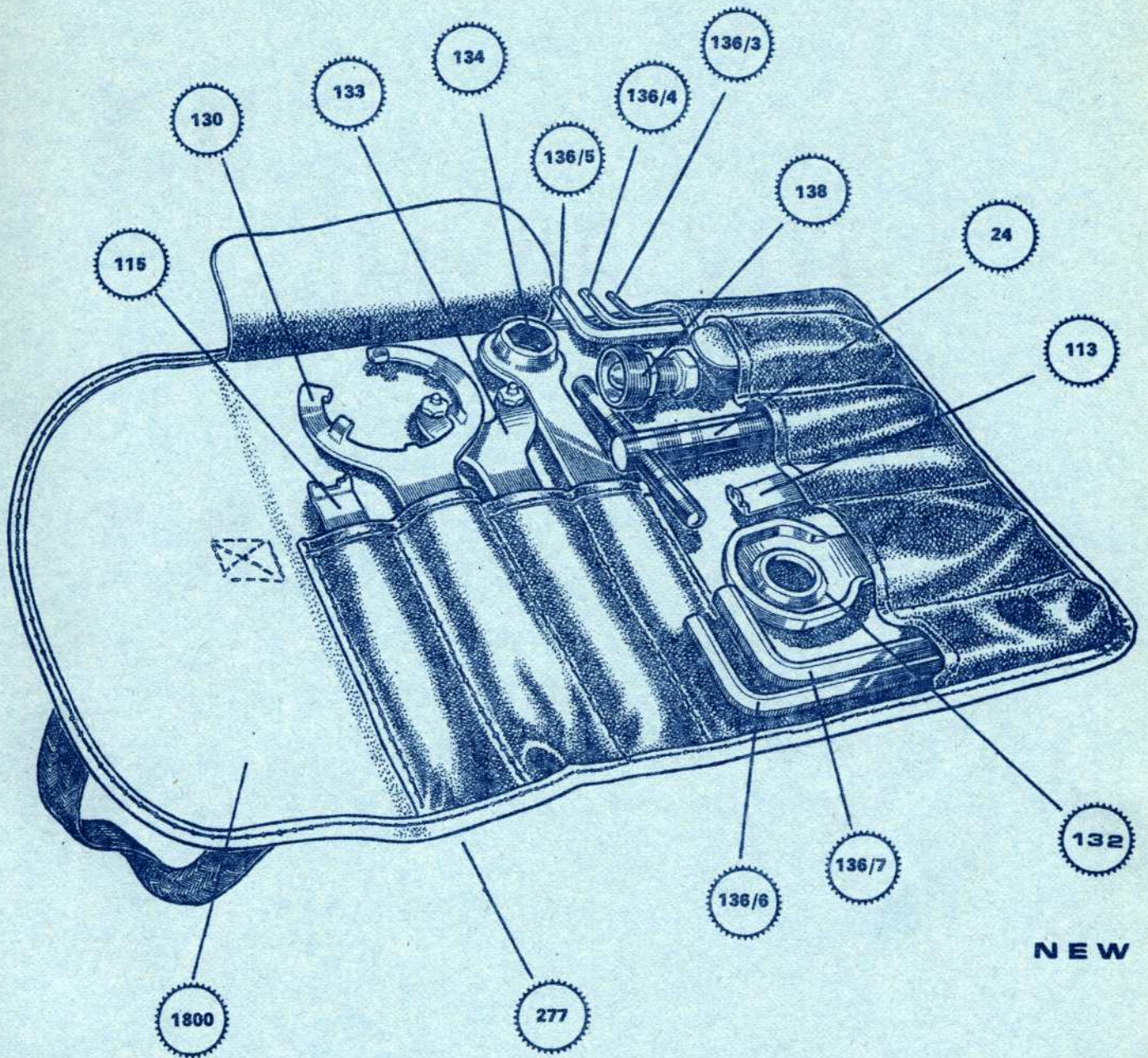

NEW !

1800 Complete tool-kit.

277 tool-kit only.

24 Special key for 5 pins chainwheel bolts and collars for bottle-cage.

113 Special screwdriver to assembly chainwheels on the crank arm 3 pins.

115 Screwdriver to assembly 5 pins chainwheels together.

130 Special key to block the lock-ring on the frame box.

132 Special key to block the stationary cup on the frame box

133 Special key to fit the adjusting cup.

33 Spur for key 133.

134 Special key to fit the crank on the axle with the screw 37 or to unfit it with the extractor 138.

136/3 Allen key 3 mm.

136/4 Allen key 4 mm.

136/5 Allen key 5 mm.

136/6 Allen key 6 mm.

136/7 Allen key 7 mm.

138 Extractor to unfit the crank.

T.A.

LIVRE VITE !

T.A.

propose de vous livrer
encore plus vite en indiquant
les numéros de références
sur vos commandes